



2024

POIDS LOURDS - REMORQUES - UTILITAIRES
TRUCKS - TRAILERS - LCV
LKW - ANHÄNGER - NUTZFAHRZEUGE



DRL

Transport Vehicle Parts & Services

www.drl-irl.com



Photos à 360°
360° pictures
360° Fotos



Fiches produits détaillées
Detailed product sheets
Detaillierte Produktblätter



Centre de téléchargement
Download center
Download-Center



Aide questions produits
Product questions help
Produktfragen helfen

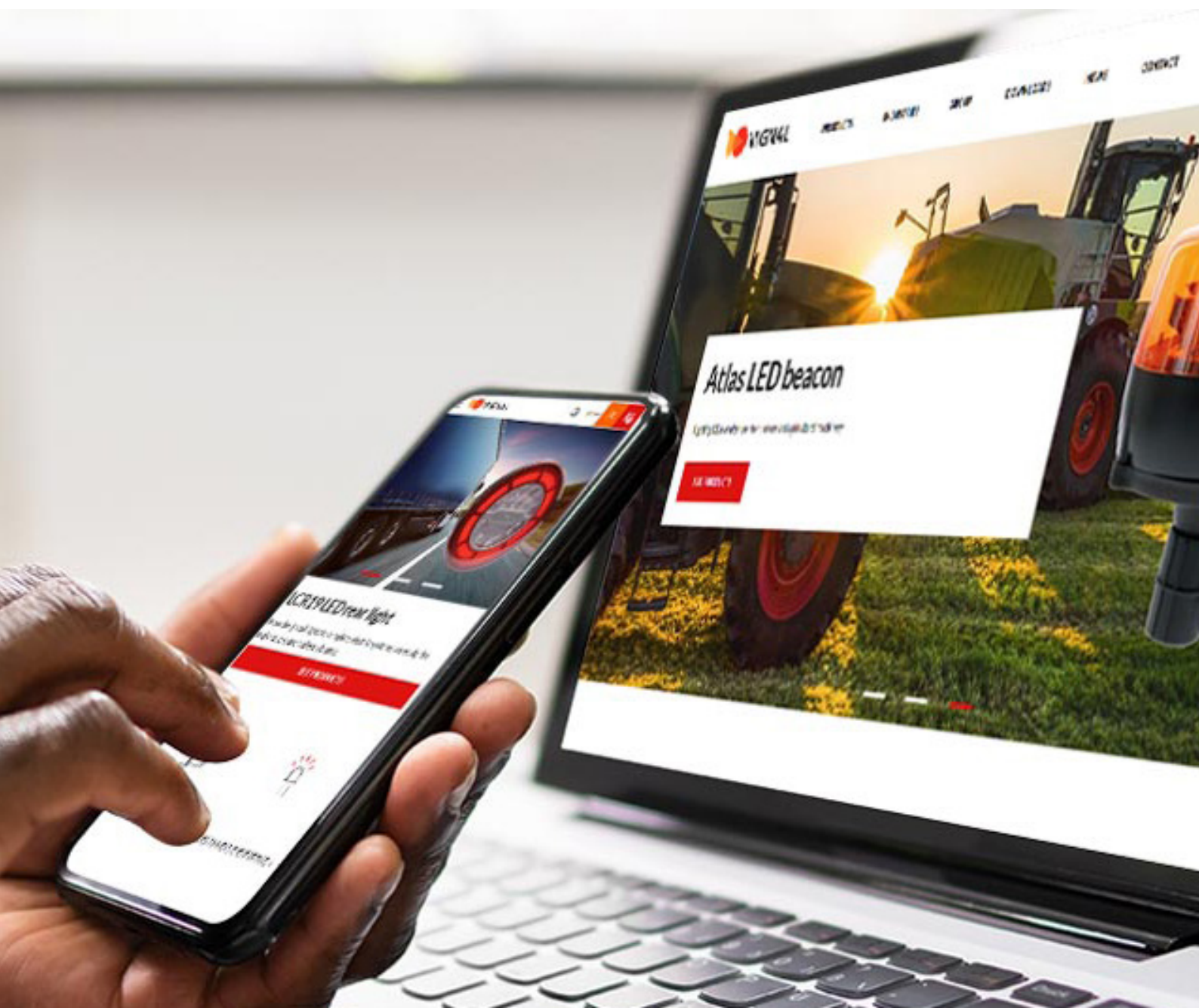

ALMAJDOUIE.....	8
ASCA.....	10
BENALU GROUP	14
CHEREAU	17
DAF	20
DE BUF	25
FELDBINDER	27
FIAT	29
FORD	30
FRUEHAUF	31
GROSSE EQUIPEMENT	33
IVECO	34
LAMBERET.....	44
LECAPITAINE.....	48
LECIÑENA.....	49
MAGYAR.....	51
MAN	52
MERCEDES / DAIMLER	55
NISSAN	58
OMEPS.....	59
OPEL.....	61
PEUGEOT CITROËN	62
RENAULT TRUCKS.....	63
SCANIA	91
SCHMITZ	93
SOR IBERICA	95
TROUILLET.....	97
UD TRUCKS.....	98
VAK OY.....	99
VOLKSWAGEN	100
VOLVO TRUCKS.....	101

SIGNALISATION - SIGNALLING - SIGNALISIERUNG

Feux arriere - Rear lamps - Heckleuchten.....	111
Eclaireurs de plaque - Number plate lamps - Kennzeichenleuchten	149
Feux clignotants - Flasher lamps - Fahrtrichtungsanzeiger	153
Feux de position- Position lamps - Positionsleuchten.....	159
Feux de gabarits - End outline marker lamps - Begrenzungsleuchten.....	173
Signalisation passive - Warning products - Warnmarkierungen.....	179

ECLAIRAGE - LIGHTING - BELEUCHTUNG

Phares de recul - Reverse work lights - Rückfahrlicht Arbeitsscheinwerfer	186
Phares de travail - Work Lights - Arbeitsscheinwerfer.....	185
Éclairage de sécurité - Warning Lights - Sicherheitsbeleuchtungen	201
Phares de conduite - Headlights - Fahrlichter	202
Feux auxiliaire - Auxiliary Lights - Zusatzsscheinwerfer.....	209
Éclairage intérieur - interior Lights - innenraum-Beleuchtungen.....	214

PRODUITS DE SÉCURITÉ - SAFETY PRODUCTS - SICHERHEITSPRODUKT

Gyrophares - Beacons - Rundumkennleuchten.....	218
Rampes lumineuses - Lightbars - Warnbalken	231
Triflash.....	233
Feux de pénétration - Directional light - Warnleuchten	237
Alarmes sonores de recul - Back up alarms - Rückfahrwarner	240
Systèmes caméras - Camera systems - Kamera-Systeme	243
Coffres porte extincteur - Extinguisher boxes - Feuerlöscher Behälter	251

ÉLECTRIQUE-ÉLECTRONIQUE - ELECTRICAL-ELECTRONICS - ELEKTRISCH-ELEKTRONISCHE

Prises et câbles spiralés - Plugs and coils - Stecker und Spiralkabel.....	253
Connecteurs - Connectors - Anschlussstecker.....	259
Faisceaux - Harnesses - Kabelsatz.....	263
Systèmes câblage et feux - Wiring and lamps systems - Verkabelung und leuchten systeme	272

RECHERCHE PRODUITS - PRODUCTS RESEARCH - PRODUKTSUCHE

Par liste de correspondance - By cross list - nach Hersteller-Nr	276
Par référence - By part number - nach Artikelnummer	280
Par no. d'homologation - By homologation number - nach Homologationsnummer	282
Par photo - By pictures - nach Abbildung	285

Vignal Group, le spécialiste de l'éclairage et de la sécurité pour véhicules industriels et commerciaux.

Vignal Group, the lighting and safety specialist for industrial and commercial vehicles.

Vignal Group, der Beleuchtungs- und Sicherheitsspezialist für Industrie- und Nutzfahrzeuge.



+20 ans de politique RSE
+20 years of CSR policy
+20 Jahre CSR-Politik



Certifié - Certified - Zertifiziert
ISO 14001 - ISO 9001
IATF 16949 - CCC - Certifier



Une croissance constante
A consistent growth
Ein stetiges Wachstum



10% des personnes en R&D
10% of people in R&D
10 % der Personen in F&E

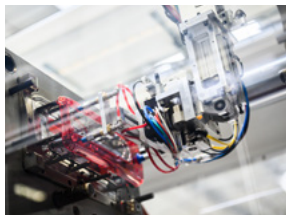

Une solution globale... A complete solution... Eine umfassende Lösung...



...pour vos véhicules. ...for your vehicles. ... für Ihre Fahrzeuge.



Des marques validées par les constructeurs.

OE approved brands.

Vom Fahrzeughersteller validierte Marken.



Notre philosophie est de concevoir globalement et de produire localement. Nos sites sont présents sur trois continents pour vous offrir la meilleure flexibilité pour le meilleur service possible.

Our philosophy is to have a global design for a local production. Our sites are located on three continents to offer you more flexibility for a better service.

Unsere Philosophie ist es, global zu designen und lokal zu produzieren. Unsere Standorte befinden sich auf drei Kontinenten, um Ihnen die bestmögliche Flexibilität und den bestmöglichen Service zu bieten.



Vignal a fait du développement durable l'un de ses axes stratégiques majeurs.

Vignal has turned sustainable development into one of its main strategic focus.

Vignal hat die nachhaltige Entwicklung zu einem seiner strategischen Hauptschwerpunkte gemacht.



Produits d'origine constructeurs

OE spare parts per manufacturer

Originalersatzteile Fahrzeughersteller



AMP 1.5-7P-M

Type connecteur - Nb pins - Mâle ou Femelle
Connector type - Pins Nb - Male or Female
Steckertyp - Stifte Nb - männlich oder weiblich



Flashez le QR code pour plus d'infos
Scan the QR code for more info
Scannen Sie den QR-Code für weitere Informationen



Pièces détachées
Spare parts
Ersatzteile

08/2020 ->

Dates d'application
Application dates
Baujahr



p. 154

Número page produit standard
Standard product page number
Standardproduktseitennummer



Faisceau p. 266
Harness p. 266
Anschlusskabel siehe S. 266

DETAIL CONNECTEUR 1.3	Abbildung des Pinnummern- Schemas	FUNKTION
1	STOP	STOP
2	POSITION	POSITION
3	REVA	REVA
4	INDICATEUR DE DIRECTION	INDICATOR
5	STOP	STOP
6	REOUVERTURE	REOUVERTURE
7	NOT USED	NOT USED

Pinning connecteurs sur notre site web
Connectors pinning on our website
Anschlüsse feststecken auf unsere Website

Ce catalogue présente une sélection d'application première monte constructeurs pour les poids lourds, camions, semi-remorques et utilitaires. Pour les autres applications véhicules (agricole, construction, cars et bus, road service...), veuillez vous référer au site web et à nos autres documentations.

This catalog presents a selection of OEM applications for trucks, semi-trailers and vans. For other vehicle applications (agricultural, construction, coach and bus, road service...), please refer to our website and other documentation.

Dieser Katalog enthält eine Auswahl an Erstausrüstungsanwendungen von Herstellern für LKWs, Lastkraftwagen, Sattelschlepper und Nutzfahrzeuge. Für andere Fahrzeuganwendungen (Landwirtschaft, Bauwesen, Busse und Reisebusse, Road Service...) verweisen wir auf unsere Website und unsere anderen Dokumentationen.

ALMAJDOUIE

LC12T LED p. 112

LED

 24V



161000



161190



gauche - left - links



AMP 1.5-7P-M

arrière

rear connector

Anschlusstecker hinten



161010



161180



droit - right - rechts



D11868

AMP 1.5-7P-F

LC8T p. 133



156040



gauche - left - links



AMP 1.5-7P-M

arrière

rear connector

Anschlusstecker hinten



156050



droit - right - rechts



D11868

AMP 1.5-7P-F



056700



gauche - left - links



056710



droit - right - rechts

LPL18 p. 150

LED

 12/24V



199040

SS-2P-M



D13880

SS-2P-F

SMD04 p. 165

LED

 24V



104260

1500 mm 

CLICK-IN

FA3LED p. 174

LED

 12/24V



D14427

1500 mm

gauche - left - links

CLICK-IN



D14428

1500 mm

droit - right - rechts

CLICK-IN

LC12T LED

 p. 112

LED

 24V



161000

gauche - left - links



AMP 1.5-7P-M

arrière
rear connector
Anschlusstecker hinten



161010

droit - right - rechts



D11868

AMP 1.5-7P-F

LC8T

 p. 133



156040

gauche - left - links



AMP 1.5-7P-M

arrière
rear connector
Anschlusstecker hinten



156050

droit - right - rechts



156060

gauche - left - links



D11868

AMP 1.5-7P-F



056700

gauche - left - links



056710

droit - right - rechts



LC5TDX i p. 141



153660

gauche - left - links



AMP 1.5-7P-M

arrière
rear connector
Anschlussstecker hinten



153670

droit - right - rechts



D11868

AMP 1.5-7P-F

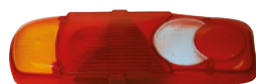

053700

gauche - left - links



053710

droit - right - rechts



LC5T i p. 140



153000

gauche - left - links



AMP 1.5-7P-M

arrière
rear connector
Anschlussstecker hinten



153010

droit - right - rechts



153020

gauche - left - links



D11868

AMP 1.5-7P-F



053700

gauche - left - links



053710

droit - right - rechts



EPP96 i p. 152



D10502

410 mm

CLICK-IN

EPP96 LED

 p. 151

LED

 24V



D13609 400 mm
CLICK-IN

FE04

 p. 160

LED

 24V



104310 5000 mm



D10132 200 mm

SMD98

 p. 161

LED

 24V



D11399 1500 mm **K**
CLICK-IN



001716

SMD04

 p. 160

LED

 24V



104140 1500 mm **K**
CLICK-IN



104100 1500 mm **K**
CLICK-IN



104260 1500 mm **K**
CLICK-IN



104220 1500 mm **K**
CLICK-IN

DXLC8 p. 175



D13034

gauche - left - links

CLICK-IN



D13035

droit - right - rechts

CLICK-IN

DX p. 176



D12428

W5W

1400 mm

CLICK-IN

FA3LED p. 174

LED

 12/24V



D14427

1500 mm

gauche - left - links

CLICK-IN



D14428

1500 mm

droit - right - rechts

CLICK-IN

MDJ p. 265



175020

BENALU GROUP

LC12 LED

 p.112

LED

 24V



161000
gauche - left - links



AMP 1.5-7P-M
arrière
rear connector
Anschlusstecker hinten



161010
droit - right - rechts



D11868 **AMP 1.5-7P-F**

NEW



D14781 **SS-2P-F**
gauche - left - links

NEW



D14782 **SS-2P-F**
droit - right - rechts

LCR19

 p.114

LED

 24V

NEW



213010 **AMP MCP-4P-M**

NEW



213090 **AMP MCP-4P-M**

NEW



213150 **AMP MCP-4P-M**

SMC
Position latéral clignotant
Side marker flashing lamp
Blinkende seiten markierungs
leuchte

POS
Position
Schlußlicht

Position Glowing - Stop - Clignotant
Glowing position - Stop - Indicator
Glowing Schlusslicht - Bremslicht - Blinker

Position Glowing - Stop - Clignotant
Glowing position - Stop - Indicator
Glowing Schlusslicht - Bremslicht - Blinker

Recul - Brouillard
Reverse - Fog
Rückfahrlicht - Nebelschlusslicht

RI

RI
Resistance intégrée (contrôle
défaillance indicateur)
Integrated resistance (indicator
failure control)
Integrierter widerstand (blin-
kleuchtenausfallkontrolle)



LC8T i p. 133



156040

gauche - left - links



AMP 1.5-7P-M

arrière
rear connector
Anschlussstecker hinten



156050

droit - right - rechts



D11868

AMP 1.5-7P-F



056700

gauche - left - links



056710

droit - right - rechts



001830



LPL18 i p. 150

LED

NEW

12/24V



199040

SS-2P-M



D13880

SS-2P-F

SMD04 i p. 160

LED

24V



104140

1500 mm **K**

CLICK-IN



104090

500 mm **K**

104100

1500 mm **K**

CLICK-IN



104260

1500 mm **K**

CLICK-IN

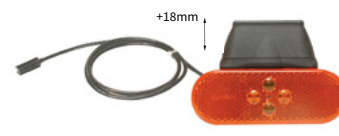

104640

300 mm **K**

104650

1000 mm **K**

bride rallongée - extended bracket - Montagewinkel verlängerter

CLICK-IN

BENALU GROUP

SMD98

 p. 161

LED



24V



D11399 1500 mm

K

CLICK-IN



001716

DXLC8

 p. 175



D12712

gauche - left - links

POS-2P-F



D12711

droit - right - rechts

POS-2P-F

ASR

 p. 241



12/24V

Multi-Frequency

Standard



D13810

1500 mm

97 dB



CLICK-IN



630120

87 dB



SL 1000

 p. 188

LED



12/24V

NEW



D14850

BL15-CTL15

i p. 120

LED

24V



Exemple de montage - Assembly suggestion - Montagebeispiel



DT04-4P-M



164000
(OE 21153)



DT04-4P-M



DTM04-4P-M



164010
(OE 21154)

Pour raccordement sur feu BL15
To plug in BL15 lamp
Zum direkten Anschluss an die leuchte BL15



165020
(OE 21781)

gauche - left - links



DT04-4P-M



DTM06-4S-4P-F



165030
(OE 21155)

droit - right - rechts



D14436 DT06-4S-4P-F



D14437 DTM06-4S-4P-F



D14435 DTM04-4P-M

LC8T

i p. 133



156040

T FPL

156060

T FPL EPP

gauche - left - links



AMP 1.5-7P-M

arrière
rear connector
Anschlussstecker hinten



156050

T FPL

156070

T FPL EPP

droit - right - rechts



D11868 AMP 1.5-7P-F



056700

T

gauche - left - links



056710

T

droit - right - rechts

LC8

 p. 130



156550

gauche - left - links



AMP 1.5-7P-M

arrière
rear connector
Anschlusstecker hinten



156540

droit - right - rechts



D11868

AMP 1.5-7P-F

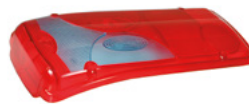

056000

gauche - left - links

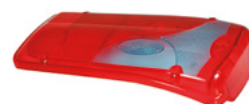

056010

droit - right - rechts



001846

LC5T

 p. 140

NEW



153160

gauche - left - links



AMP 1.5-7P-M

arrière
rear connector
Anschlusstecker hinten

NEW



153170

droit - right - rechts



SS-2P-M



153020

gauche - left - links

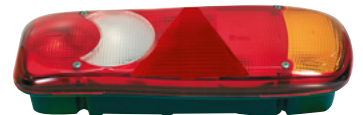

153010

droit - right - rechts



D11868

AMP 1.5-7P-F



053700

gauche - left - links



053710

droit - right - rechts



EPP96

 p. 150



196020

R10W

SL 1000

 p. 186

LED

 12/24V

 R23



D14857

DT-2P-M

Feu homologué recul - Homologated reverse lamp -
Genehmigt Rückfahrleuchte



D14170

DT-2P-F

04/2012 ->



155100
(OE 1875577)   
gauche - left - links



HDSCS-8P-M
latéral
side connector
Anschlussstecker seitlich



155110
(OE 1875576)  
droit - right - rechts



Entraxe : 160 mm
Bolt distance : 160 mm
Schraubenabstand : 160 mm



155120
(OE 1875578)   
droit - right - rechts

04/2012 ->



155130
(OE 1875580)   
gauche - left - links



HDSCS-8P-M
arrière
rear connector
Anschlussstecker hinten



155140
(OE 1875579)  
droit - right - rechts



155150
(OE 1875581)   
droit - right - rechts



D13878 **HDSCS-8P-F**



055020
(OE 1914690) 
gauche - left - links



055030
(OE 1914691) 
droit - right - rechts



001830
(OE 1973239) 
Alarme sonore de recul
Back up alarm
Rückfahrtsignalhorn

CF / XF

LC7

 p. 141

1995 -> 04/ 2012



1995 ->2001



167640
(OE 1284211)  

168020
(OE 1304789)   

gauche - left - links



DAF
arrière
rear connector
Anschlusstecker hinten



167630
(OE 1284212) 

168010
(OE 1304788)  

droit - right - rechts



168890
(OE 1660967)   

droit - right - rechts

2001 -> 04/2012



169160
(OE 1625985)   

gauche - left - links





AMP 1.5-7P-M
latéral
side connector
Anschlusstecker seitlich



169170
(OE 1625986)  

droit - right - rechts



169380
(OE 1660968)   

droit - right - rechts



D11868 **AMP 1.5-7P-F**



067500
(OE 1272653) 

gauche - left - links



067500
(OE 1272653) 

droit - right - rechts



D12953
(OE 1519358) 

Alarme sonore de recul
Back up alarm
Rückfahrtsignalhorn

ICDL07

 p. 156

1993 ->



109010
(OE 1814096/1815754)

ICDL10

 p.156

01/2013 ->



117000
(OE 1846491)

gauche - left - links



117010
(OE 1846492)

droit - right - rechts



001619

75 - 85 - XF - CF

FPL93

 p.168



193020
(OE 1329718)

K

JPT-2P-M



193200
(OE 1653605)

K

JPT-2P-M



001726
(OE 1608352)



D13876

JPT-2P-F

LF

LC5

 p.137

2001 ->



152170
(OE 1401713)

K

EPP

gauche - left - links



AMP 1.5-7P-M

arrière
rear connector
Anschlusstecker hinten



152180
(OE 1401731)

K

droit - right - rechts



D11868

AMP 1.5-7P-F



052500
(OE 1451482)

K

gauche - left - links



052500
(OE 1451482)

K

droit - right - rechts

LF

FE95

 p. 162



195010
(OE 1403887)

gauche - left - links



195010
(OE 1403887)

droit - right - rechts

ICDL94

 p. 157



119550
(OE 1626101)

JPT-3P-M



001616
(OE 1626102)



D13877 **JPT-3P-F**

FE02

 p. 162



102200
clippé - clipped - befestigung

K

JPT-2P-M



001726
(OE 1608352)



D13876 **JPT-2P-F**

FPL93

 p. 168



193020
(OE 1329718)

K

JPT-2P-M



001726
(OE 1608352)



D13876 **JPT-2P-F**

EPP98

 p. 152



196010
(OE 0867930)



JPT-2P-M



D13876 **JPT-2P-F**

1993 -> 1995



168100
(OE 1626319/1284213)   
gauche - left - links



DIN
arrière
rear connector
Anschlussstecker hinten



168390
(OE 1626320/1284214)   
droit - right - rechts



067500
(OE 1272653) 
gauche - left - links



067500
(OE 1272653) 
droit - right - rechts

LC12 LED p. 112



GLOWING

161280  

gauche - left - links



ORIGINAL

161000  

gauche - left - links



AMP 1.5-7P-M
arrière
rear connector
Anschlussstecker hinten



161290  

droit - right - rechts



161010  

droit - right - rechts



D11868 **AMP 1.5-7P-F**

EPP96 LED p. 151



R14364 2000 mm

SS-2P-F

SMD04 p. 160



104140 1500 mm 

CLICK-IN



104100 1500 mm 

CLICK-IN

DE BUF

FA3 LED p. 174

LED

 12/24V



D14425

gauche - left - links

SS-2P-F



D14426

droit - right - rechts

SS-2P-F

SL 1000 p. 186

LED

 12/24V

 R23



D14857

DT-2P-M

Feu homologué recul - Homologated reverse lamp -
Genehmigt Rückfahrleuchte



D14170

DT-2P-F

SL 1500 p. 188

LED

 12/24V

NEW



D14851

DT-2P-M



D14170

DT-2P-F

ATLAS p. 220

LED

 12/24V



212420



D14513

LC12 LED p. 112

LED

 24V



161000

gauche - left - links



AMP 1.5-7P-M

arrière
rear connector
Anschlussstecker hinten



161010

droit - right - rechts



D11868 AMP 1.5-7P-F

LC8T p. 134



156250

gauche - left - links



AMP 1.5-7P-M

arrière
rear connector
Anschlussstecker hinten



156260

droit - right - rechts



D11868 AMP 1.5-7P-F



056720

gauche - left - links



056730

droit - right - rechts



SMD04 p. 160

LED

 24V



104140

1500 mm 

CLICK-IN



104260

1500 mm 

CLICK-IN

FELDBINDER

SMD98

 p.161

LED

 24V



D10500

500 mm 

D11399

1500 mm 

CLICK-IN



D10497

500 mm 

CLICK-IN

FA3 LED

 p. 174

LED

 12/24V



D14425

gauche - left - links

SS-2P-F



D14426

droit - right - rechts

SS-2P-F

DXLC8

 p. 175



D12712

gauche - left - links

POS-2P-F



D12711

droit - right - rechts

POS-2P-F

ASR

 p. 241

 12/24V

Standard



630120

87 dB



DUCATO

LC5

 p.138

07/2012 ->



Fixation 4 vis M6 (190x60mm)
Fixing 4 screws M6 (190x60mm)
Befestigung 4 Schrauben M6
(190x60mm)



153270
(OE 1372699080)

gauche - left - links



AMP 1.5-7P-M
arrière
rear connector
Anschlusstecker hinten



153280
(OE 1372698080)

droit - right - rechts



D11868 **AMP 1.5-7P-F**



052500
gauche - left - links



052500
droit - right - rechts



FPL93

 p.168



193360
(OE 1356794080 / 71749250)

SS-2P-M



193170
(OE 1305797)

SS-2P-M



001916



D13880 **SS-2P-F**

SS-2P-F

NEW



D16109
(OE 1940131)



gauche - left - links

NEW



D16108
(OE 1940132)



droit - right - rechts

LC12 LED p. 112



161000  
gauche - left - links



AMP 1.5-7P-M
arrière
rear connector
Anschlussstecker hinten



161010  
droit - right - rechts

LC8T p. 133



156040  
gauche - left - links



AMP 1.5-7P-M
arrière
rear connector
Anschlussstecker hinten



156050  
droit - right - rechts



D11868 **AMP 1.5-7P-F**



056700 
gauche - left - links



056710 
droit - right - rechts



001830 

BL15 p. 120



165040
gauche - left - links



DT04-4P-M



DTM06-4S-4P-F



165050
droit - right - rechts



D14436 **DT06-4S-4P-F**



D14437 **DTM06-4S-4P-F**



D14435 **DTM04-4P-M**

EPP96 LED p. 151



D13609 400 mm

CLICK-IN

FRUEHAUF

EPP96

 p. 152



196020 R10W



D11888 1000 mm
CLICK-IN

DXLC8

 p. 175



D12712 350 mm
gauche - left - links
POS-2P-F



D12711 350 mm
droit - right - rechts
POS-2P-F

FA3 LED

 p. 174

LED

 12/24V



D14427 1500 mm
gauche - left - links
CLICK-IN



D14428 1500 mm
droit - right - rechts
CLICK-IN

SMD04

 p. 160

LED

 24V



104130 500 mm **K**

104140 1500 mm **K**

CLICK-IN



104090 500 mm **K**

104100 1500 mm **K**

CLICK-IN

5054

 p. 251



Max 6 kg

D14538

K Catadioptré
Reflector
Rückstrahler

T Catadioptré triangulaire
Triangular reflector
Dreieckrückstrahler

 Connecteurs additionnels
Additional connectors
Zusätzliche elektrische anschlüsse

LC12 LED

 p. 112

LED

 24V



161000



gauche - left - links



AMP 1.5-7P-M
arrière
rear connector
Anschlussstecker hinten



161010



droit - right - rechts



D11868 **AMP 1.5-7P-F**



D14781

SS-2P-F

gauche - left - links



D14782

SS-2P-F

droit - right - rechts

LC5TDX

 p. 141



153660



gauche - left - links



AMP 1.5-7P-M
arrière
rear connector
Anschlussstecker hinten



153670



droit - right - rechts



D11868 **AMP 1.5-7P-F**



053700



gauche - left - links



053710



droit - right - rechts

EPP96 LED

 p. 151

LED

 24V



D13609

400 mm

CLICK-IN

LED

 24V

03/2016 ->





160150  
(OE 5802062689 / 5802240291)
gauche - left - links



HDSCS-8P-M
latéral
side connector
Anschlussstecker seitlich





160100  
(OE 5802000573 / 5802240295)
droit - right - rechts



160080   
(OE 5802000568 / 5802240292)
gauche - left - links



160090   
(OE 5802000767 / 5802240296)
droit - right - rechts

03/2016 ->



160110  
(OE 5802000570 / 5802240293)
gauche - left - links





HDSCS-8P-M
arrière
rear connector
Anschlussstecker hinten





160130  
(OE 5802000770 / 5802240297)
droit - right - rechts



160140   
(OE 5802055273 / 5802240294)
gauche - left - links



160120   
(OE 5802000772 / 5802240298)
droit - right - rechts



D13878 **HDSCS-8P-F**



060000 
gauche - left - links



060010 
droit - right - rechts

03/2016 ->



155450
(OE 5801637199)   
gauche - left - links





HDSCS-8P-M
latéral
side connector
Anschlussstecker seitlich



155460
(OE 5801637201)  
droit - right - rechts



155470
(OE 5801637202)   
droit - right - rechts

DESIGN EFFET FUMÉ - MÉTALLISÉ
SMOKED EFFECT & METTALIZED DESIGN
DESIGN RAUCHEFFEKT - METALLEFFEKT

03/2016 ->



155480
(OE 5801637182)  
gauche - left - links



HDSCS-8P-M
arrière
rear connector
Anschlussstecker hinten



155490
(OE 5801757328)  
droit - right - rechts



155540
(OE 5802055272)   
gauche - left - links



155500
(OE 5801757326)   
droit - right - rechts



D13878 **HDSCS-8P-F**



055040 
gauche - left - links



055050 
droit - right - rechts



001830 
Alarme sonore de recul
Back up alarm
Rückfahrtsignalhorn

06/2011 -> EURO 6



153220
(OE 5801426889)

gauche - left - links



AMP 1.5-7P-M
arrière
rear connector
Anschlussstecker hinten



153210
(OE 5801426894)

droit - right - rechts



153200
(OE 5801426912)

gauche - left - links



153230
(OE 5801426917)

droit - right - rechts



153240
(OE 5801426975)

gauche - left - links



153250
(OE 5801426977)

droit - right - rechts



153260
(OE 5801426979)

droit - right - rechts



D11868 **AMP 1.5-7P-F**



052500
(OE 42566495)

gauche - left - links



052500
(OE 42535711)

droit - right - rechts



FPL93

 p. 168



193020
(OE 500308514)



JPT-2P-M



001726
(OE 1608352)



D13876 **JPT-2P-F**

SMD98

 p. 166

-> 10/2014

LED

 24V



198760
(OE 5801631615)



SS-2P-M



D13880 **SS-2P-F**

STRALIS - TRAKKER - EURO CARGO

LC7

 p. 143

09/2011 -> EURO 6



169390
(OE 5801363428)  
gauche - left - links



DIN-8P-M
arrière
rear connector
Anschlussstecker hinten



169410
(OE 5801363431)  
droit - right - rechts



169400
(OE 5801363430)   
gauche - left - links



169420
(OE 5801363432)   
droit - right - rechts



067500
(OE 93161844) 
gauche - left - links



067500
(OE 93161844) 
droit - right - rechts



D12953 

STRALIS - TRAKKER - ASTRA HD7/HD8

C105

 p. 154

09/2012 ->



110550
(OE 5801572024)
gauche - left - links



110560
(OE 5801572018)
droit - right - rechts



001619

FPL93

 p. 168



193170
(OE 41200664) 
superseal **SS-2P-M**



001916



D13880 **SS-2P-F**

2002 ->



168610
(OE 99463244)
gauche - left - links



IVECO
arrière
rear connector
Anschlussstecker hinten



168600
(OE 99463242)
droit - right - rechts



168480
(OE R504083205)
droit - right - rechts



067500
(OE 93161844)
gauche - left - links



067500
(OE 93161844)
droit - right - rechts



D12953



2002 -> 05/2007



119920
(OE 41221041)
gauche - left - links



119930
(OE 41221040)
droit - right - rechts

05/2007 -> 09/2012



110520
(OE 42555042)
gauche - left - links



110530
(OE 42555041)
droit - right - rechts



001619



Catadioptr
Reflector
Rückstrahler



Feu de position latéral
Side marker lamp
seitenmarkierungsleuchte



Eclaireur de plaque
Number plate lamp
Kennzeichenleuchte



Alarme sonore de recul
Back up alarm
Rückfahrtsignalhorn

EUROCARGO

LC7

 p. 143

1996 ->



168590
(OE 99463243)  
gauche - left - links



IVECO
arrière
rear connector
Anschlusstecker hinten



168600
(OE 99463242)  
droit - right - rechts



168610
(OE 99463244)   
gauche - left - links



067500
(OE 93161844) 
gauche - left - links



067500
(OE 93161844) 
droit - right - rechts

C105

 p. 154

06/2008 -> 09/2012



110520
(OE 42555042)
gauche - left - links

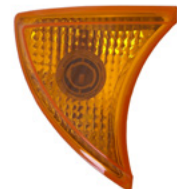

110530
(OE 42555041)
droit - right - rechts

09/2012 ->



110550
(OE 5801572024)
gauche - left - links



110560
(OE 5801572018)
droit - right - rechts



001619

1996 -> 2002



168610
(OE 99463244)
gauche - left - links



IVECO
arrière
rear connector
Anschlusstecker hinten



168600
(OE 99463242)
droit - right - rechts



067500
(OE 93161844)
gauche - left - links



067500
(OE 93161844)
droit - right - rechts



193020
(OE 500308514)



JPT-2P-M



001726
(OE 1608352)



D13876 JPT-2P-F

MASSIF 4 X 4

2002 ->



152180
(OE 791123)
gauche - left - links



AMP 1.5-7P-M
arrière
rear connector
Anschlusstecker hinten



152180
(OE 791123)
droit - right - rechts



D11868 AMP 1.5-7P-F



052500
(OE A610067-002)
gauche - left - links



052500
(OE A610067-002)
droit - right - rechts



DAILY LC15

 p. 137

07/2021 >

NEW



154200
(OE 5802830033 EZ)
gauche - left - links





AMP 1.5-7P-M
arrière
rear connector
Anschlussstecker hinten

NEW



154210
(OE 5802830034 EZ)
droit - right - rechts



NEW



154220
(OE 5802980630 EZ)
gauche - left - links



NEW



154220
(OE 5802980631 EZ)
droit - right - rechts





D11868 **AMP 1.5-7P-F**



053730
(OE 5802984152 EZ)
gauche - left - links





053730
(OE 5802984152 EZ)
droit - right - rechts



725

 p. 148

06/2006 -> 06/2021



D12334
(OE 69500032)
gauche - left - links





AMP 1.5-6P-M
arrière
rear connector
Anschlussstecker hinten



D12335
(OE 69500026)
droit - right - rechts





D11868 **AMP 1.5-7P-F**



D12336
(OE 42555132)
gauche - left - links





D12337
(OE 42555131)
droit - right - rechts



06/2006 ->



D12338
(OE 69500591) **3.5T** **K**

D12340
(OE 69500047) **5T** **K**

gauche - left - links



D12339
(OE 69500590) **3.5T** **K**

D12341
(OE 69500044) **5T** **K**

droit - right - rechts

725

i p. 148

1999 -> 06/2006



D11482
(OE 500356783) **K**

gauche - left - links



AMP 1.5-5P-M
arrière
rear connector
Anschlussstecker hinten



D11481
(OE 500356782) **K**

droit - right - rechts



D11868 **AMP 1.5-7P-F**



D11480 **K**

gauche - left - links



D11479 **K**

droit - right - rechts

LC7

i p. 143

1996 -> 1999



168590
(OE 99463243) **K** **FPL**

gauche - left - links



IVECO
arrière
rear connector
Anschlussstecker hinten



168600
(OE 99463242) **K** **FPL**

droit - right - rechts



067500
(OE 93161844) **K**

gauche - left - links



067500
(OE 93161844) **K**

droit - right - rechts

1996 ->



193020
(OE 500308514)

K

JPT-2P-M



001726
(OE 1608352)



D13876

JPT-2P-F



193290
(OE 504097923)

K

SS-2P-M



D13880

SS-2P-F

LAMBERET

LC12T LED

 p.112

LED

 24V



161000
gauche - left - links



AMP 1.5-7P-M
arrière
rear connector
Anschlusstecker hinten



161010
droit - right - rechts



D11868 **AMP 1.5-7P-F**



D11689 **AMP 1.5-7P**

LC12 LED

 p.112

LED

 24V



161260
gauche - left - links



AMP 1.5-7P-M
arrière
rear connector
Anschlusstecker hinten



161270
droit - right - rechts



D11868 **AMP 1.5-7P-F**



D11689 **AMP 1.5-7P**

LC8T

 p.133



156040
gauche - left - links



AMP 1.5-7P-M
arrière
rear connector
Anschlusstecker hinten



156050
droit - right - rechts



D11868 **AMP 1.5-7P-F**



056700
gauche - left - links



056710
droit - right - rechts



D11689 **AMP 1.5-7P**

LC8

 p. 130



156310

gauche - left - links



AMP 1.5-7P-M

arrière
rear connector
Anschlussstecker hinten



156300

droit - right - rechts



D11868

AMP 1.5-7P-F

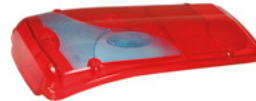

056500

gauche - left - links

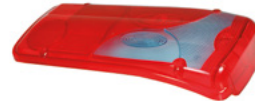

056510

droit - right - rechts



D11689

AMP 1.5-7P

LC5T

 p. 140



153000

gauche - left - links



AMP 1.5-7P-M

arrière
rear connector
Anschlussstecker hinten



153010

droit - right - rechts



D11868

AMP 1.5-7P-F

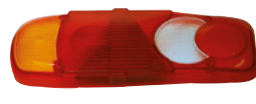

053700

gauche - left - links

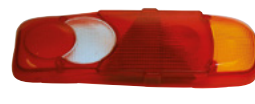

053710

droit - right - rechts



LPL18

 p. 150

LED

 12/24V



199040

SS-2P-M



D13880

SS-2P-F

LAMBERET

EPP96 LED

 p. 151

LED

 24V



D13874 2000 mm
POS-2P-F

EPP96

 p. 152



196020



D10227 700 mm
POS-2P-F

FE04

 p. 170

LED

 24V



104330 500 mm

SMD04

 p. 160

LED

 24V



104130 500 mm 
CLICK-IN



104090 500 mm 
104100 1500 mm 



104170 500 mm 
CLICK-IN



D14214
POS-2P-M

SMD98 p.166

LED

 24V



D10496 1500 mm 
CLICK-IN



001716

FA3 LED p.174

LED

 12/24V



D13875 1000 mm

SL 1000 p.186

LED

 12/24V

 R23



D14880

RCL 1200 p.215

LED

 9/30V

 1200 Lumen



300010



300000

chromé - chrome-plated - verchromt

MDJ p.265



175020

BL15-CTL15 p. 120

LED

⚡ 24V



Exemple de montage - Assembly suggestion - Montagebeispiel



164050
(OE 661058)



164010

Pour raccordement sur feu BL15
To plug in BL15 lamp
Zum direkten Anschluss an die leuchte BL15



165020

gauche - left - links



165030

droit - right - rechts



p. 267



D11689 **AMP 1.5-7P**

LC8T p.134



156250  
gauche - left - links



AMP 1.5-7P-M
arrière
rear connector
Anschlussstecker hinten



156260  
droit - right - rechts



156380   
gauche - left - links



156390   
droit - right - rechts



D11868 **AMP 1.5-7P-F**



056720 
gauche - left - links



056730 
droit - right - rechts

LC5T p.140

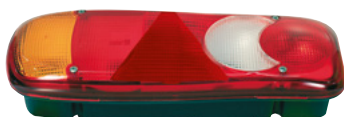

153000 
gauche - left - links



AMP 1.5-7P-M
arrière
rear connector
Anschlussstecker hinten

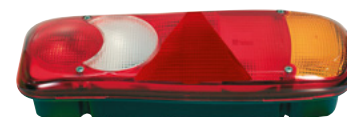

153010 
droit - right - rechts



153130  
droit - right - rechts



D11868 **AMP 1.5-7P-F**



053700 
gauche - left - links



053710 
droit - right - rechts

LECINENA

LC12T LED

 p.112

LED

 24V



161000
gauche - left - links



AMP 1.5-7P-M
arrière
rear connector
Anschlusstecker hinten



161010
droit - right - rechts



D11868 **AMP 1.5-7P-F**



D11689 **AMP 1.5-7P-M**

SMD04

 p.160

LED

 24V



104140 1500 mm **K**

CLICK-IN



104100 1500 mm **K**

CLICK-IN



104250 500 mm **K**

CLICK-IN

FPL93

 p.162



193200 **K**

JPT-2P-M



001726



D13876 **JPT-2P-F**

SMD98

 p.166

LED

 24V



D10494 500 mm **K**



001786 500 mm **K**

LC12 LED p. 112

LED

 24V



161000



gauche - left - links



AMP 1.5-7P-M
arrière
rear connector
Anschlusstecker hinten



161010



droit - right - rechts



D11868 **AMP 1.5-7P-F**



D14781
gauche - left - links



D14782
droit - right - rechts

LCR19 p. 114

LED

 24V

NEW



213070

AMP MCP-4P-M

POS
Position
Schlußlicht

Position Glowing - Stop - Clignotant
Glowing position - Stop - Indicator
Glowing Schlußlicht - Bremslicht - Blinker

NEW



213150

AMP MCP-4P-M

Recul - Brouillard
Reverse - Fog
Rückfahrlicht - Nebelschlußlicht



002100



POS
POS



R23

SL 1000 p. 186

LED

 12/24V

 **R23**



D14857

DT-2P-M

Feu homologué recul - Homologated reverse lamp -
Genehmigt Rückfahrleuchte



D14170

DT-2P-F

04/2017 ->
12V



155550
(OE 65.25225-6004 / 7CE 945 095)
gauche - left - links



AMP 1.5-7P-M
arrière
rear connector
Anschlusstecker hinten

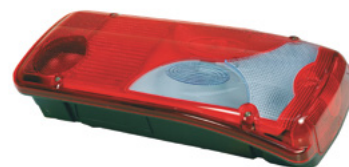

155560
(OE 65.25225-6005 / 7CE 945 096)
droit - right - rechts



TGA - TGL - TGM - TGX - TGS

2005 ->



156200
(OE 8125225-6544)
gauche - left - links



AMP 1.5-7P-M
latéral
side connector
Anschlusstecker seitlich

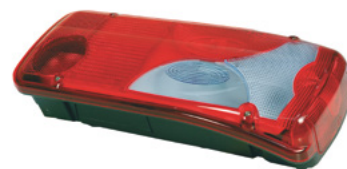

156210
(OE 8125225-6545)
droit - right - rechts



156220
(OE 8125225-6547)
droit - right - rechts



D11868 **AMP 1.5-7P-F**



056500
(OE 8125229-6059 / 65.25229.0000 / 7CE 945 111)
gauche - left - links

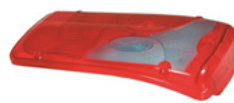

056510
(OE 8125229-6060 / 65.25229.001 / 7CE 945 112)
droit - right - rechts



001830 90 Db
001872 55-90 Db



LED

 10/110V

03/2018 ->



212020
(OE 81.25207-6074)
POS-2P-M



212030
(OE 81.25207-6075)
POS-2P-M



D13879 **POS-2P-F**

SLA 2000

 p. 189

01/2022 ->

 LED

 12/24V

NEW



D16110
(OE 81.25103-6076)

LEAR-2P-M

TGA

LC7

 p. 142

1999 -> 2005



169180
(OE 8125225-6526)

gauche - left - links



AMP 1.5-7P-M

latéral
side connector
Anschlussstecker seitlich



169170
(OE 8125225-6523)

droit - right - rechts



169160
(OE 8125225-6524)

gauche - left - links



169190
(OE 8125225-6530)

droit - right - rechts



D11868 **AMP 1.5-7P-F**



067500
(OE 8125229-6051)



gauche - left - links



067500
(OE 8125229-6051)



droit - right - rechts

1990 -> 2004



168090
(OE 8125225-6033)



gauche - left - links



DIN 72480-8P-M
arrière
rear connector
Anschlusstecker hinten



168090
(OE 8125225-6464)



droit - right - rechts



168100
(OE 8125225-6034)



gauche - left - links



168490
(OE 8125225-6528)



droit - right - rechts



067500
(OE 8125229-6051)



gauche - left - links



067500
(OE 8125229-6051)



droit - right - rechts

ACTROS - UNIMOG

ATLAS

 p. 220



ACTROS 08/2020 ->

UNIMOG 03/2023 ->

LED

 24V



212710
(OE A 960 820 02 58 / A 960 820 03 58)  
MQS-2P-M





212420
(OE A 910 906 69 00 / A 405820 0158)  

ZETROS

LC8

09/2019 ->





155590
(OE A 959 544 01 03)   
gauche - left - links





AMP 1.5-7P-M
arrière
rear connector
Anschlussstecker hinten



155600
(OE A 959 544 02 03)  
droit - right - rechts



155610
(OE A 959 544 03 03)   
droit - right - rechts



D11868 **AMP 1.5-7P-F**



056540
(OE A 000 826 20 56) 
gauche - left - links



056550
(OE A 000826 21 56) 
droit - right - rechts



001830
Alarme sonore de recul
Back up alarm
Rückfahrsignalhorn

LC11



 p. 117

03/2018 ->

 LED

 12V





160400
(OE A 910 820 64 00)   

gauche - left - links



AMP 1.5-7P-M
arrière
rear connector
Anschlusstecker hinten



160410
(OE A 910 820 65 00)  

droit - right - rechts



D11868 



060000
(OE A 910 826 10 00) 

gauche - left - links



060010
(OE A 910 826 11 00) 



droit - right - rechts

LC8

 p. 132

06/2006 ->





156340
(OE A 906 820 04 64)   

gauche - left - links



AMP 1.5-7P-M
arrière
rear connector
Anschlusstecker hinten



156350
(OE A 906 820 17 64)  

droit - right - rechts



D11868 



056540
(OE A 000 826 20 56) 

gauche - left - links



056550
(OE A 000 826 21 56) 

droit - right - rechts

ATLAS



 p. 220

03/2018 ->

 LED



 9/32V



212010
(OE A 910 906 29 00 / A 910 906 64 00)  

KOSTAL-2P-M



212420
(OE A 910 906 69 00)  

ECONIC

SMD98

 p. 166

04/2019->

LED

 24V



198760
(OE A 956 544 00 11)

K

SS-2P-M



D13880

SS-2P-F

FE08 H1

04/2019->

LED

 24V



116200
(OE A 956 820 00 59)

ATLAS

 p. 220

11/2023 ->

LED

 9/32V



212710
(OE A 960 820 02 58)



MQS-2P-M

SONDERFAHRZEUG

EPP96

 p. 152

06/2012 -> Lowliner



196170
(OE A 949 540 01 04) 500 mm

HDSCS-3P-M



152170
(OE 26555-9X126)



gauche - left - links



AMP 1.5-7P-M

arrière
rear connector
Anschlusstecker hinten



152180
(OE 26555-9X125)



droit - right - rechts



153120
(OE 26555-9X128)



droit - right - rechts



D11868 **AMP 1.5-7P-F**



052500
(OE 26554-9X126)



gauche - left - links



052500
(OE 26554-9X126)



droit - right - rechts



119550
(OE 26164-9X402)



001616
(OE 26244-9X400)



D13877 **JPT-3P-F**

LC12 LED i p. 112

LED

⚡ 24V



161280

gauche - left - links



AMP 1.5-7P-M

arrière
rear connector
Anschlusstecker hinten



161290

droit - right - rechts



D11868

AMP 1.5-7P-F



D14781

SS-2P-F

gauche - left - links



D14782

SS-2P-F

droit - right - rechts

LCR19 i p. 114

LED

⚡ 24V

NEW



213010

AMP MCP-4P-M

Position Glowing - Stop - Clignotant
Glowing position - Stop - Indicator
Glowing Schlusslicht - Bremslicht - Blinker

NEW



213070

AMP MCP-4P-M

Position Glowing - Stop - Clignotant
Glowing position - Stop - Indicator
Glowing Schlusslicht - Bremslicht - Blinker

NEW



213150

AMP MCP-4P-M

Recul - Brouillard
Reverse - Fog
Rückfahrlicht - Nebelschlusslicht

SMC
Position latéral clignotant
Side marker flashing lamp
Blinkende seiten markierungs
leuchte

POS
Position
Schlußlicht

RI
Resistance intégrée (contrôle
défaillance indicateur)
Integrated resistance (indicator
failure control)
Integrierter widerstand (blin-
kleuchtenausfallkontrolle)

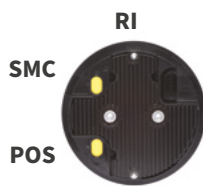

EPP96 LED i p. 151

LED

⚡ 12/24V



R14364

SS-2P-M

SMD04 p. 160

LED

 12/24V



104690

K

SS-2P-M



104670

K

SS-2P-M



D13880

SS-2P-F

CARBONLUX p. 186

LED

 10/30V

 R23



D14811

DT-2P-M



Interrupteur - switch - Schalter



D14170

DT-2P-F

5054 p. 251



Max 6 kg

D14538

MOVANO - VIVARO

LC5

 p. 137

04/2010 ->



152180
(OE 4421265)

gauche - left - links





AMP 1.5-7P-M

arrière
rear connector
Anschlussstecker hinten



152180
(OE 4421266)

droit - right - rechts





D11868 **AMP 1.5-7P-F**



052500

gauche - left - links





052500

droit - right - rechts



EPP98

 p. 152

04/2010 ->



196010
(OE 4421269)

JPT-2P-M



D13876

JPT-2P-F

LC5

 p. 138

07/2012 ->



Fixation 4 vis M6 (190x60mm)
Fixing 4 screws M6 (190x60mm)
Befestigung 4 Schrauben M6
(190x60mm)



153270 
(OE 6350FS / 9815127080)

gauche - left - links



AMP 1.5-7P-M
arrière
rear connector
Anschlussstecker hinten



153280 
(OE 6351FS / 9815126980)

droit - right - rechts



D11868 **AMP 1.5-7P-F**



052500 
gauche - left - links



052500 
droit - right - rechts

EURO 6 - T / K / C

LC9 LED

 p. 118



EURO 6

LED

 24V

12/2017->





158030
(OE 7425982261 / 7422800385 / 7484585208)   

gauche - left - links





AMP 1.5-7P-M
latéral
side connector
Anschlussstecker seitlich



158050
(OE 7425982262 / 7423080010 / 7484585206)  

droit - right - rechts



158040
(OE 7425982262 / 7422800386 / 7484585204)   

droit - right - rechts



D11868 **AMP 1.5-7P-F**



058000
(OE 7422800391) 

gauche - left - links



058000
(OE 7422800391) 

droit - right - rechts

ATLAS

 p. 220

LED

 9/32V

09/2021->



212740
(OE 23811106) 
AMP-4P-F



212750
(OE 23811107) 
AMP-4P-F

TRI

 p. 184



D10596
(OE 7423374865)

RENAULT TRUCKS

EURO 6 - T / K / C --> 520 CH

LC9

 p. 135

EURO6

11/2013 ->



159010
(OE 7420802348)   
gauche - left - links



AMP 1.5-7P-M
latéral
side connector
Anschlussstecker seitlich



159020
(OE 7420802350)  
droit - right - rechts



159030
(OE 7420802353)
droit - right - rechts



D11868 **AMP 1.5-7P-F**



059000
(OE 7420802418) 
gauche - left - links



059000
(OE 7420802418) 
droit - right - rechts



D12953 

LC10 LED

 p. 119

EURO6

 LED

 24V

09/2020->



159500
(OE 7423530440)   
gauche - left - links



AMP 1.5-7P-M
latéral
side connector
Anschlussstecker seitlich



159530
(OE 7423530442)  
droit - right - rechts



159520
(OE 7423530438)  
gauche - left - links



159510
(OE 7423530441)   
droit - right - rechts



D11868 **AMP 1.5-7P-F**



059500
(OE 7423292490) 
gauche - left - links



059500
(OE 7423292490) 
droit - right - rechts

EURO 6 - T / K / C --> 520 CH

SMD00

 p. 167

EURO6

LED

 24V

12/2013->



198620
(OE 7482392733)



Cuve blanche - cabochon PMMA
White body - PMMA lens
Weißes Gehäuse - PMMA Lichtscheibe



198740
(OE 7482586940)



Cuve ambre - cabochon PC haute température
Amber body - PC lens high temperature
Oranges Gehäuse - PC Lichtscheibe hoch temperatur beständig

FE18

EURO6

09/2021 ->

NEW



123000
(OE 7423398399)

gauche - left - links

NEW



123000
(OE 7423398399)

droit - right - rechts

NEW



123020
(OE 7423398397)

gauche - left - links

NEW



123010
(OE 7423398400)

droit - right - rechts

SL18

EURO6

09/2021 ->

NEW

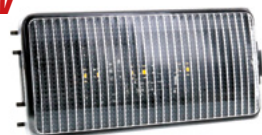

113100
(OE 7423398635)

Feu d'embarquement
Step lamp
Einstiegsbeleuchtung

FE09

EURO6

11/2013 -> 10/2021



115020
(OE 7482346591)
gauche - left - links



115020
(OE 7482346591)
droit - right - rechts



115000
(OE 7482252506)
gauche - left - links



115010
(OE 7482367030)
droit - right - rechts



115040
(OE 7482252291)



115030
(OE 7482255014)

SL08

EURO6

11/2013 -> 10/2021



113020
(OE 7482266219) 10W
Lampe de portière
Door lamp
Türleuchte



113030
(OE 7482285707) 5W
Feu d'embarquement
Step lamp
Einstiegsbeleuchtung

MAGNUM

LC9

 p.135

01/2006 ->



159010
(OE 7420802348)   
gauche - left - links



AMP 1.5-7P-M
latéral
side connector
Anschlussstecker seitlich



159020
(OE 7420802350)  
droit - right - rechts



159030
(OE 7420802353)   
droit - right - rechts



D11868 **AMP 1.5-7P-F**



059000
(OE 7420802418) 
gauche - left - links



059000
(OE 7420802418) 
droit - right - rechts



D12953 

LC7

 p.141

09/2004 -> 01/2006



169310
(OE 5001864535)    
gauche - left - links



AMP 1.5-7P-M
latéral
side connector
Anschlussstecker seitlich



169320
(OE 5001864536)   
droit - right - rechts



Entraxe : 160 mm
Bolt distance : 160 mm
Schraubenabstand : 160 mm



D11868 **AMP 1.5-7P-F**



067500
(OE 5001847588) 
gauche - left - links



067500
(OE 5001847588) 
droit - right - rechts

12/1998 -> 09/2004



169020
(OE 5001847586)
gauche - left - links



AMP 1.5-7P-M
latéral
side connector
Anschlussstecker seitlich

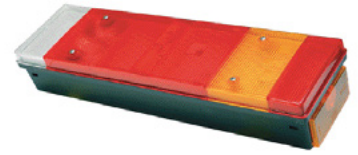

169030
(OE 5001847587)
droit - right - rechts



169000
(OE 5001847584)
gauche - left - links



169010
(OE 5001847585)
droit - right - rechts



D11868 **AMP 1.5-7P-F**

1990 -> 1994



167100
(OE 5000296592)
gauche - left - links



PE arrière
rear connector
Anschlussstecker hinten



167000
(OE 5000296592)
droit - right - rechts

1994 -> 12/1998



168220
(OE 5001831194)
gauche - left - links



168260
(OE 5001832999)
droit - right - rechts



067000
(OE 5000296594)



067000
(OE 5000296594)

067500
(OE 5001847588)
gauche - left - links



067500
(OE 5001847588)
droit - right - rechts



1991 -> 12/1998



166100 *
(OE 5000296591)

gauche - left - links



PE
arrière
rear connector
Anschlussstecker hinten



166000 *
(OE 5000296591)

droit - right - rechts

12/1998 -> 09/2004



169060
(OE 5001847582)

gauche - left - links



AMP 1.5-7P-M
latéral
side connector
Anschlussstecker seitlich



169070
(5001847583)

droit - right - rechts



D11868 **AMP 1.5-7P-F**



066000
(OE 5000296593)

gauche - left - links



066000
(OE 5000296593)

droit - right - rechts

RENAULT TRUCKS

MAGNUM

FE04

 p. 160

 LED

 24V

06/2008 ->



104570
(OE 7421430181/7482562006)





104450
(OE 7421137718)





D14170 

FPL93

 p. 168

1994 ->



193020
(OE 5010306792 / 7484538758) 





001726
(OE 5001847589)

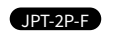

D13876 

FE02

 p. 162

2003 ->



102200
(OE 5001862030) 

Clippé - clipped - clip-befestigung





001726
(OE 5001847589)



D13876 

PREMIUM / KERAX / EURO 6 - C --> 320 CH

LC9

 p.135

EURO 6

01/2006 ->



159010
(OE 7420802348)   
gauche - left - links



AMP 1.5-7P-M
latéral
side connector
Anschlussstecker seitlich



159020
(OE 7420802350)  
droit - right - rechts



159030
(OE 7420802353)   
droit - right - rechts



D11868 **AMP 1.5-7P-F**



059000
(OE 7420802418) 
gauche - left - links



059000
(OE 7420802418) 
droit - right - rechts



D12953 

PREMIUM / KERAX

LC7

 p.141

Premium
09/2004 -> 01/2006
Kerax
09/2004 -> 09/2006



Entraxe : 160 mm
Bolt distance : 160 mm
Schraubenabstand : 160 mm



169310
(OE 5001864535)    
gauche - left - links



AMP 1.5-7P-M
latéral
side connector
Anschlussstecker seitlich

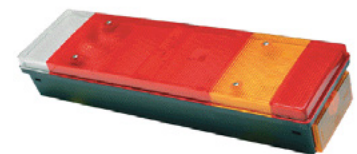

169320
(OE 5001864536)   
droit - right - rechts



D11868 **AMP 1.5-7P-F**



067500
(OE 5001847588) 
gauche - left - links



067500
(OE 5001847588) 
droit - right - rechts

Premium
1999 -> 09/2004



169020
(OE 5001847586)
gauche - left - links



AMP 1.5-7P-M
latéral
side connector
Anschlussstecker seitlich

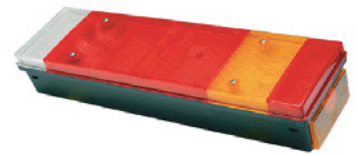

169030
(OE 5001847587)
droit - right - rechts



Premium
1999 -> 09/2004
Kerax
09/1998 -> 09/2004



169000
(OE 5001847584)
gauche - left - links

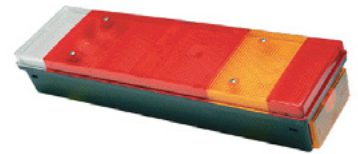

169010
(OE 5001847585)
droit - right - rechts



D11868

AMP 1.5-7P-F



067000
(OE 5000296594)

067500
(OE 5001847588)
gauche - left - links



067000
(OE 5000296594)

067500
(OE 5001847588)
droit - right - rechts



D12953



Premium
1995 -> 1999
Kerax
1995 -> 09/1998



168220
(OE 5001831194)



 **168260**
(OE 5001832999)
gauche - left - links



PE
arrière
rear connector
Anschlussstecker hinten

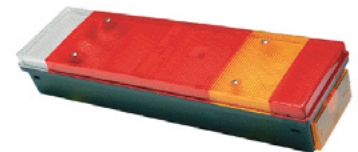

168260
(OE 5001832999)



 **168140**
(OE 5001835853)
droit - right - rechts



067000
(OE 5000296594)
gauche - left - links



067000
(OE 5000296594)
droit - right - rechts

PREMIUM / KERAX

LC5

Premium
06/2001 -> 09/2004



152020 *
(OE 5001846847)



152510 **
(OE 5001857964)



gauche - left - links



AMP 1.5-7P-M

arrière
rear connector
Anschlusstecker hinten



152500 **
(OE 5001858092)



152520 *
(OE 5001857965)

droit - right - rechts

* pas de fonction recul
* no reverse function
* ohne Rückfahrchein werfer

** pas de fonction brouillard
** no fog function
** ohne Nebelschlussleuchte



D11868 AMP 1.5-7P-F



052000
(OE 5010392231)
gauche - left - links



052000
(OE 5010392231)
droit - right - rechts

LC6

p. 145

Premium
12/1998 -> 09/2004



169060
(OE 5001847582)



gauche - left - links



AMP 1.5-7P-M

latéral
side connector
Anschlusstecker seitlich



169070
(OE 5001847583)

droit - right - rechts

Premium
1995 -> 12/1998



166100 *
(OE 5000296591)



gauche - left - links



PE
arrière
rear connector
Anschlusstecker hinten



166000 *
(OE 5000296591)

droit - right - rechts

Kerax
1995 -> 09/1998



D11868 AMP 1.5-7P-F



066000
(OE 5000296593)
gauche - left - links



066000
(OE 5000296593)
droit - right - rechts

FE95

 p.162

EURO 6

1995 ->



195010
(OE 5001834561)
gauche - left - links



195010
(OE 5001834561)
droit - right - rechts

ICDL94

 p.157

EURO 6

1995 ->



119450
(OE 5001834565)

5W

JPT-3P-M



119470
(OE 5001847597)

21W

JPT-3P-M

Premium 12/1998 ->
Kerax 1999 ->



001616
(OE 5001834568)



D13877

JPT-3P-F

FE02

 p.162

EURO 6

2003 ->



102200
(OE 5001862030)

K

Clippé - clipped - clip-befestigung

JPT-2P-M



001726
(OE 5001847589)



D13876

JPT-2P-F

PREMIUM / KERAX / EURO 6 - C --> 320 CH

SMD98

 p.166

EURO6

LED

 24V

09/2007 ->



198650
(OE 7421106206)

K

Feu d'identification Viscope
Viscope identification lamp
Markierungsleuchte Viscope

JPT-2P-M

D13876

JPT-2P-F

FPL93

 p. 162

2003 ->



1995 ->



193200
(OE 5001862030)

K

Vissé - Screwed - Geschraubt

JPT-2P-M

193020
(OE 5010306792)

K

JPT-2P-M



001726
(OE 5001847589)

D13876

JPT-2P-F

MIDLINER

LC4

 p. 146



141500
(OE 5000808172)

K

EPP

gauche - left - links



PE
arrière
rear connector
Anschlussstecker hinten



141500
(OE 5000808172)

K

EPP

droit - right - rechts



040500
(OE 5000808166)

K

gauche - left - links

040500
(OE 5000808166)

K

droit - right - rechts

RENAULT TRUCKS

EURO 6 - D --> 18 T

LC10 LED ⓘ p. 119

EURO 6

LED

⚡ 24V

09/2020->



159500
(OE 7423530440) K FPL EPP
gauche - left - links



AMP 1.5-7P-M
latéral
side connector
Anschlussstecker seitlich



159530
(OE 7423530442) K FPL
droit - right - rechts



159520
(OE 7423530438) K FPL
gauche - left - links



159510
(OE 7423530441) K FPL 🔊
droit - right - rechts



D11868 AMP 1.5-7P-F



059500
(OE 7423292490) K
gauche - left - links



059500
(OE 7423292490) K
droit - right - rechts

LC5 ⓘ p. 137

EURO 6

09/2021->



152170
(OE 5010595381) K EPP
gauche - left - links



AMP 1.5-7P-M
arrière
rear connector
Anschlussstecker hinten



152180
(OE 5010595382) K
droit - right - rechts



D11868 AMP 1.5-7P-F



052500
(OE 5001847153) K
gauche - left - links



052500
(OE 5001847153) K
droit - right - rechts

MIDLUM / EURO 6 - D --> 18 T

LC7

 p. 141

1999 -> 04/2006



169000
(OE 5001847584)   
gauche - left - links



AMP 1.5-7P-M
latéral
side connector
Anschlusstecker seitlich



169010
(OE 5001847585)  
droit - right - rechts



D11868 **AMP 1.5-7P-F**



067500
(OE 5001847588) 
gauche - left - links



067500
(OE 5001847588) 
droit - right - rechts

LC5

 p. 137

EURO 6

09/2005 ->



152880
(OE 7420862032) 
gauche - left - links



AMP 1.5-7P-M
arrière
rear connector
Anschlusstecker hinten



152880
(OE 7420862035) 
droit - right - rechts

1999 -> 09/2005





* pas de fonction recul
* no reverse function
* ohne Rückfahrchein werfer

** pas de fonction brouillard
** no fog function
** ohne Nebelschlussleuchte





152000 *
(OE 5001846843) 

 **152040 ****
(OE 5001846845) 

gauche - left - links



152010 **
(OE 5001846844) 

 **152050 ***
(OE 5001846846) 

droit - right - rechts



D11868 **AMP 1.5-7P-F**



052500
(OE 5001847153) 
gauche - left - links



052500
(OE 5001847153) 
droit - right - rechts

RENAULT TRUCKS

MIDLUM / EURO 6 - D --> 18 T

LC5

 p. 137

EURO6

09/2005 ->



152190
(OE 7420862038)
gauche - left - links





AMP 1.5-7P-M
arrière
rear connector
Anschlusstecker hinten



152200
(OE 7420862041)
droit - right - rechts

1999 -> 09/2005



* pas de fonction recul
* no reverse function
* ohne Rückfahrchein werfer

** pas de fonction brouillard
** no fog function
** ohne Nebelschlussleuchte



152020 *
(OE 5001846847)





152060 **
(OE 5001846849)



gauche - left - links



152030 **
(OE 5001846848)



152070 *
(OE 5001846850)

droit - right - rechts



D11868 **AMP 1.5-7P-F**



052000
(OE 5010392231)
gauche - left - links



052000
(OE 5010392231)
droit - right - rechts

EPP96

 p. 152

1999 -> 2003



196020
(OE 7700353021)

EPP98

 p. 152

EURO6

2003 ->



196010
(OE 5010293829)



D13876 **JPT-2P-F**

JPT-2P-M



MIDLUM / EURO 6 - D --> 18 T

FM91

08/2008 ->



191170
(OE 7421268609)

ICDL94

 p. 157

EURO6

-> 1999



119450
(OE 5001834565)

5W

JPT-3P-M

1999 ->



119470
(OE 5001847597)

21W

JPT-3P-M



001616
(OE 5001834568)



D13877

JPT-3P-F

FE95

 p. 162

EURO6

1999 ->



195010
(OE 5001834561)

gauche - left - links



195010
(OE 5001834561)

droit - right - rechts

FE02

 p. 162

EURO6

2003 ->



102200
(OE 5001862030)

Clippé - clipped - clip-befestigung

K

JPT-2P-M



001726
(OE 5001847589)



D13876

JPT-2P-F

RENAULT TRUCKS

MIDLUM / EURO 6 - D --> 18 T

FPL93

 p. 168

1999 ->



193020
(OE 5010306792)



JPT-2P-M



193280
(OE 7420894265)



JPT-2P-M



001726
(OE 5001847589)



D13876

JPT-2P-F

MAXITY / EURO 6 - D --> 7,5 T

LC5

 p. 137

EURO 6

2009 ->



152170
(OE 7485118470)
gauche - left - links



AMP 1.5-7P-M

arrière
rear connector
Anschlussstecker hinten



152180
(OE 5001870556)
droit - right - rechts





D11868

AMP 1.5-7P-F



052500
(OE 5001847153)
gauche - left - links





052500
(OE 5001847153)
droit - right - rechts



MASCOTT

LC5

EURO 6

04/2006 ->



152880
(OE 7420862032) K
gauche - left - links



AMP 1.5-7P-M
arrière
rear connector
Anschlussstecker hinten



152880
(OE 7420862035) K
droit - right - rechts

07/2001 -> 04/2006

* pas de fonction recul
* no reverse function
* ohne Rückfahrchein werfer

** pas de fonction brouillard
** no fog function
** ohne Nebelschlussleuchte



152000 *
(OE 5001846843) K
gauche - left - links



152600 **
(OE 5001858093) K
droit - right - rechts



D11868 **AMP 1.5-7P-F**



052500
(OE 5001847153) K
gauche - left - links



052500
(OE 5001847153) K
droit - right - rechts

LC5

i p. 137

04/2006 ->



152170 K EPP
gauche - left - links



AMP 1.5-7P-M
arrière
rear connector
Anschlussstecker hinten



152180 K
droit - right - rechts



D11868 **AMP 1.5-7P-F**



052500
(OE 5001847153) K
gauche - left - links



052500
(OE 5001847153) K
droit - right - rechts

RENAULT TRUCKS

MASCOTT

LC5

07/2001 -> 04/2006

* pas de fonction recul
* no reverse function
* ohne Rückfahrchein werfer

** pas de fonction brouillard
** no fog function
** ohne Nebelschlussleuchte



152020 *
(OE 5001846847)

EPP



152510 **
(OE 5001857964)

EPP

gauche - left - links



AMP 1.5-7P-M

arrière
rear connector
Anschlussstecker hinten



152500 **
(OE 5001858092)



152520 *
(OE 5001857965)

droit - right - rechts



D11868 AMP 1.5-7P-F



052000
(OE 5010392231)
gauche - left - links



052000
(OE 5010392231)
droit - right - rechts

LC4

i p. 146

1998 -> 07/2001



141500
(OE 5000808172)
gauche - left - links

K EPP



PE
arrière
rear connector
Anschlussstecker hinten



141500
(OE 5000808172)
droit - right - rechts

K EPP



040500
(OE 5000808166)
gauche - left - links

K



040500
(OE 5000808166)
droit - right - rechts

K

EPP98

i p. 152

1998 ->



196010
(OE 5010293829)

JPT-2P-M



D13876 JPT-2P-F



MASCOTT

ICDL94

 p. 157

1998 ->



119450
(OE 5001834565) 5W
JPT-3P-M



001616
(OE 5001834568)



D13877 JPT-3P-F

SMD98

 p.166

LED

 4xLEDS - 12V

1998 ->



198510
(OE 7700377208) K
JPT-2P-M



D13876 JPT-2P-F

CA

 p. 184

1998 -> 04/2006

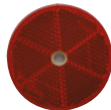

D14590
(OE 7700377130)

04/2006 ->

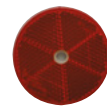

D14593
(OE 8200602314)

TRAFIC

LC5

 p. 137

10/2014 ->



152180
(OE 265551402R) K

152180
(OE 265550674R) K 

gauche - left - links



AMP 1.5-7P-M

arrière
rear connector
Anschlussstecker hinten



152180
(OE 265504514R) K

152180
(OE 265500292R) K 

droit - right - rechts



D11868 AMP 1.5-7P-F



052500
(OE 5001847153) K

gauche - left - links



052500
(OE 5001847153) K

droit - right - rechts

RENAULT TRUCKS

MASTER

LC5

 p. 137

04/2010 ->



152180
(OE 265551402R) 

152180
(OE 265550674R)  
gauche - left - links



AMP 1.5-7P-M

arrière
rear connector
Anschlussstecker hinten



152180
(OE 265504514R) 

152180
(OE 265500292R)  
droit - right - rechts



D11868 **AMP 1.5-7P-F**



052500
(OE 5001847153) 
gauche - left - links



052500
(OE 5001847153) 
droit - right - rechts

EPP96

 p. 152

-> 04/2010



196020
(OE 7700353021)

EPP98

 p. 152

-> 04/2010



196010
(OE 265100848R)



D13876 **JPT-2P-F**

JPT-2P-M

SMD98

 p.166

LED

 4xLEDS - 12V

-> 04/2010



198580 

JPT-2P-M



D13876 **JPT-2P-F**

GAMME B

LC4

 p. 146



141000
(OE 5000808171)
gauche - left - links





PE
arrière
rear connector
Anschlussstecker hinten



141000
(OE 5000808171)
droit - right - rechts





040000
(OE 5000807304)
gauche - left - links



040000
(OE 5000807304)
droit - right - rechts

FPL93

 p. 200



193020
(OE 5010306792 / 7484538758) 





001726
(OE 5001847589)



D13876 

RENAULT TRUCKS

GAMME C

LC4

 p. 146

-> 1986



141500
(OE 5000808172)
gauche - left - links



PE
arrière
rear connector
Anschlussstecker hinten



141500
(OE 5000808172)
droit - right - rechts



040500
(OE 5000808166)
gauche - left - links





040500
(OE 5000808166)
droit - right - rechts



FE81

 p. 158



181050
(OE 5000461059)



181000
(OE 5000461058)

FE88

 p. 178



188310
(OE 5000623050)



088010
(OE 5000296718)

GAMME G

LC4

 p. 146

-> 1986



141000
(OE 5000808171) 

141500
(OE 5000808172)  
gauche - left - links



PE
arrière
rear connector
Anschlussstecker hinten



141000
(OE 5000808171) 

141500
(OE 5000808172)  
droit - right - rechts



040000
(OE 5000807304)

040500
(OE 5000808166) 
gauche - left - links



040000
(OE 5000807304)

040500
(OE 5000808166) 
droit - right - rechts

LC6

 p. 145

1986 ->



166000
(OE 5000296591) 

gauche - left - links



PE
arrière
rear connector
Anschlussstecker hinten



166000
(OE 5000296591)

droit - right - rechts



066000
(OE 5000296593)

gauche - left - links



066000
(OE 5000296593)

droit - right - rechts

RENAULT TRUCKS

GAMME J

FE81

 p. 158



181050
(OE 5000461059)



181000
(OE 5000461058)

FE88

 p. 178



188310
(OE 5000623050)



088010
(OE 5000296718)

FPL93

 p. 168



193020
(OE 5010306792 / 7484538758) 





001726
(OE 5001847589)



D13876 

GAMME R

LC7

 p. 142

1994 ->



167100
(OE 5000296592)
gauche - left - links





PE
arrière
rear connector
Anschlussstecker hinten



167000
(OE 5000296592)
droit - right - rechts



168220
(OE 5001831194)
gauche - left - links



168260
(OE 5001832999)
droit - right - rechts



067000
(OE 5000296594)

067500
(OE 5001847588)
gauche - left - links





067000
(OE 5000296594)

067500
(OE 5001847588)
droit - right - rechts



LC4

 p. 146

-> 1994



141000
(OE 5000808171)
gauche - left - links





PE
arrière
rear connector
Anschlussstecker hinten



141000
(OE 5000808171)
droit - right - rechts





040000
(OE 5000807304)
gauche - left - links



040000
(OE 5000807304)
droit - right - rechts



RENAULT TRUCKS

GAMME R

FPL93

 p. 168



193020
(OE 5010306792 / 7484538758) 



001726
(OE 5001847589)



D13876 

GAMME S

LC4

 p. 146



141000
(OE 5000808171) 
gauche - left - links



PE
arrière
rear connector
Anschlussstecker hinten



141000
(OE 5000808171) 
droit - right - rechts



040000
(OE 5000807304)
gauche - left - links



040000
(OE 5000807304)
droit - right - rechts

FE87

 p. 178



188310
(OE 5000623050)



088010
(OE 5000296718)

SERIE P&R

LC8

 p. 131

08/2013 ->



155080
(OE 2160128)

gauche - left - links



AMP 1.5-7P-M

arrière
rear connector
Anschlusstecker hinten



155520
(OE 2340796)

droit - right - rechts



155090
(OE 2160127)

droit - right - rechts

01/2007 ->



156770
(OE 1756754/2021579/2129985)

gauche - left - links



AMP 1.5-7P-M

latéral
side connector
Anschlusstecker seitlich



156780
(OE 1756751/2021575/2129987)

droit - right - rechts



155020
(OE 2021578/2129986)

droit - right - rechts



156790
(OE 1791369/2021576/2129988)

droit - right - rechts



D11868 AMP 1.5-7P-F



056540
(OE 1784669/2129992)



gauche - left - links



056550
(OE 1784670/2129991)



droit - right - rechts



001830



1990 -> 1998



168350
(OE 1365963)   
gauche - left - links



168360
(OE 1365964)  
droit - right - rechts



067500
(OE 1350343) 
gauche - left - links



067500
(OE 1350343) 
droit - right - rechts

 LED

 12/24V

 2000 Lumen



D14852
(OE 2862201)



D14170 



D10596
(OE 2020496)

LC12 LED p. 112

LED

 24V

GLOWING



161280
(OE 1370066)  
gauche - left - links



AMP 1.5-7P-M
arrière
rear connector
Anschlusstecker hinten



161290
(OE 1370067)  
droit - right - rechts



D11868 **AMP 1.5-7P-F**



LC12 LED p. 112

LED

 24V

ORIGINAL





161000
(OE 1302341 / 1364736)  
gauche - left - links



AMP 1.5-7P-M
arrière
rear connector
Anschlusstecker hinten



161010
(OE 1302342 / 1364737)  
droit - right - rechts



D11868 **AMP 1.5-7P-F**

LCR19 p. 114

LED

 24V

SMC
Position latéral clignotant
Side marker flashing lamp
Blinkende seiten markierungs-
leuchte

POS
Position
Schlußlicht

RI
Resistance intégrée (contrôle
défaillance indicateur)
Integrated resistance (indicator
failure control)
Integrierter widerstand (blin-
kleuchtenausfallkontrolle)



213010
(OE 1415545) **AMP MCP-4P-M**

Position Glowing - Stop - Clignotant
Glowing position - Stop - Indicator
Glowing Schlußlicht - Bremslicht - Blinker



213090
(OE 1415546) **AMP MCP-4P-M**

Position Glowing - Stop - Clignotant
Glowing position - Stop - Indicator
Glowing Schlußlicht - Bremslicht - Blinker

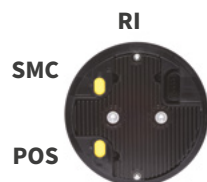



AMP-MCP-4P-F



D14846
(OE 1415543) **HDSCS-6P-F**
gauche - left - links

AMP-MCP-4P-F



D14847
(OE 1415544) **HDSCS-6P-F**
droit - right - rechts

AMP-MCP-4P-F



D14884
(OE 1437099) **HDSCS-6P-F**
gauche - left - links

AMP-MCP-4P-F



D14885
(OE 1437100) **HDSCS-6P-F**
droit - right - rechts

LED

 10/30V



D14488
(OE 1348566)  



D14513

LC12 LED p. 112

LED

 24V



161000

gauche - left - links



AMP 1.5-7P-M

arrière
rear connector
Anschlusstecker hinten



161010

droit - right - rechts



D11868

AMP 1.5-7P-F



D14781

gauche - left - links

SS-2P-F



D14782

droit - right - rechts

SS-2P-F

LC8T p. 133



156040

gauche - left - links



AMP 1.5-7P-M

arrière
rear connector
Anschlusstecker hinten



156050

droit - right - rechts



056700

gauche - left - links



056710

droit - right - rechts



D12712

gauche - left - links

POS-2P-F



D12711

droit - right - rechts

POS-2P-F



D11868

AMP 1.5-7P-F

EPP96 LED p. 151

LED

 24V



R14364

2000 mm

SS-2P-F

SOR IBERICA

EPP96

 p. 152



D11888

1000 mm

CLICK-IN

SMD04

 p. 165

LED

 24V



104100

1500 mm **K**

CLICK-IN



104650

1000 mm **K**

bride rallongée - extended bracket - Montagewinkel längerter

CLICK-IN

SMCU

 p. 165

 12/24V



D14722

SS-2P-M **SS-3P-M**

FA3LED

 p. 174

LED

 12/24V



D14427

1500 mm

gauche - left - links

CLICK-IN



D14428

1500 mm

droit - right - rechts

CLICK-IN



D14425

gauche - left - links

SS-2P-F



D14426

droit - right - rechts

SS-2P-F

BL15 p. 120

LED

 24V

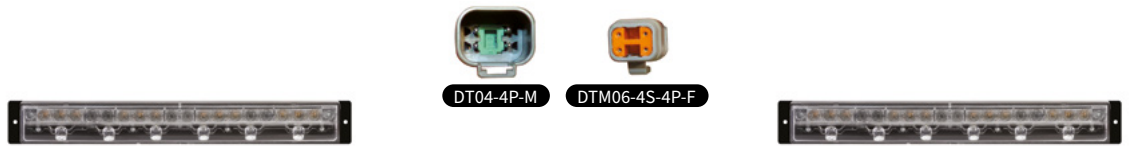

165040

gauche - left - links

165050

droit - right - rechts



CTL15 p. 120

LED

 24V



164020

gauche - left - links

164030

droit - right - rechts



CTL15-BL15 p. 121

LED

 24V

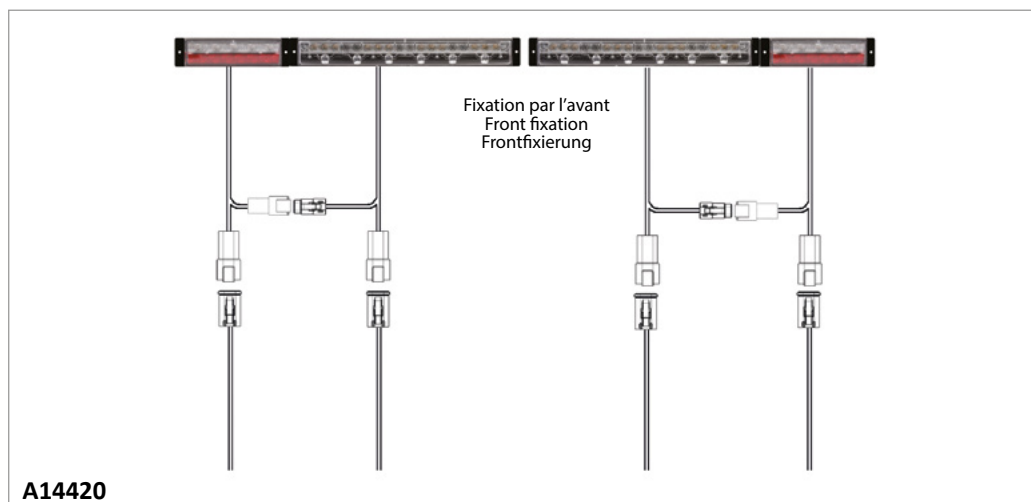

A14420

2 x CTL15 + 1 x BL15 gauche + 1 x BL15 droit + 4 câbles 8,5 m
 2 x CTL15 + 1 x left BL15 + 1 x right BL15 + 4 cables 8,5 m
 2 x CTL15 + 1 x BL15 links + 1 x BL15 rechts + 4 Verkabelung 8,5 m

UD TRUCKS

QUON - QUESTER

LC9 LED - LC10 LED



REF. sur demande

Référence sur demande
Part number on request
Artikelnummer auf Anfrage



REF. sur demande

Référence sur demande
Part number on request
Artikelnummer auf Anfrage

LC5

 p. 137

05/2015 ->



152180
(OE 261319Z01B)



153880 *
(OE 261319Z01D)



gauche - left - links



AMP 1.5-7P-M

arrière
rear connector
Anschlussstecker hinten



152180
(OE 261319Z01C)



153890 *
(OE 261319Z01E)



droit - right - rechts

* pas de fonction brouillard
* no fog function
* ohne Nebelschlussleuchte



D11868 **AMP 1.5-7P-F**



052500
(OE 265509Z00A)



gauche - left - links



052500
(OE 265509Z00A)



droit - right - rechts

EPP98

 p. 152

05/2015 ->



196010
(OE 265109Z00A)

JPT-2P-M



D13876 **JPT-2P-F**

ICDL15

 p. 156

05/2015 ->



120000
(OE 84655961) PY21W - 24V

SS-2P-M



D13880 **SS-2P-F**



LC12 LED

i | p.113

LED

24V

NEW



161700
161720

gauche - left - links



AMP 1.5-7P-M
arrière
rear connector
Anschlussstecker hinten

NEW



161710
161730

droit - right - rechts



D11868 **AMP 1.5-7P-F**

NEW



D14781 **SS-2P-F**

gauche - left - links

NEW



D14782 **SS-2P-F**

droit - right - rechts

LPL18

i | p.150

LED

12/24V

NEW



199040

SS-2P-M



D13880 **SS-2P-F**

LC8

 p. 127

06/2017 ->



155570
(OE 7CA 945 095)
gauche - left - links



AMP 1.5-7P-M
arrière
rear connector
Anschlusstecker hinten



155580
(OE 7CA 945 096)
droit - right - rechts



D11868 **AMP 1.5-7P-F**



055020
(OE 7CA 945 111)
gauche - left - links





055030
(OE 7CA 945 112)
droit - right - rechts



LC5

 p. 137

06/2017 ->



152180
(OE 7CA 945 091)
gauche - left - links



AMP 1.5-7P-M
arrière
rear connector
Anschlusstecker hinten



152180
(OE 7CA 945 092)
droit - right - rechts





D11868 **AMP 1.5-7P-F**



052500
(OE 5001847153)
gauche - left - links





052500
(OE 5001847153)
droit - right - rechts



LC8

 p. 132

06/2006 ->
05/2017



156340
(OE 2E0 945 095 A)
gauche - left - links



AMP 1.5-7P-M
arrière
rear connector
Anschlusstecker hinten



156350
(OE 2E0 945 096 A)
droit - right - rechts



D11868 **AMP 1.5-7P-F**



056540
(OE 2E0 945 111 A)
gauche - left - links





056550
(OE 2E0 945 112 A)
droit - right - rechts



FH

LC9 LED



p. 118

12/2012 ->

LED



24V

**158030**(OE 82849894 / 84195505 /
84441766 / 23354972)

gauche - left - links



AMP 1.5-7P-M

latéral
side connector
Anschlusstecker seitlich**158050**(OE 82849923 / 84195521 /
84441768 / 23354974)

droit - right - rechts

**158040**(OE 82849925 / 84195519 /
84441767 / 23354973)

droit - right - rechts

**D11868**

AMP 1.5-7P-F

**058000**

(OE 82849905)



gauche - left - links

**058000**

(OE 82849905)



droit - right - rechts

SRD08



p. 155

09/2012 ->

LED



24V

**111000**

(OE 82151157)

gauche - left - links

**111010**

(OE 82151205)

droit - right - rechts

**111020**

(OE 21346521)

gauche - left - links

**111030**

(OE 21346522)

droit - right - rechts

FH 08/2008 -> 09/2012



107000
(OE 82114506 / 82355678 / 84139927)
gauche - left - links



107010
(OE 82114500 / 82355684 / 84139939)
droit - right - rechts



107040
(OE 82114504 / 21448885)
gauche - left - links



107050
(OE 82114502 / 21478751)
droit - right - rechts



FE08 H2

09/2012 ->



112010
(OE 82278930)
gauche - left - links



112000
(OE 82278938)
droit - right - rechts



ID08

09/2012 ->



114000
(OE 21214534)



114010
(OE 82150539)



114020
(OE 21214524)



FH

FE08 H1

09/2012 ->

LED

24V



116010
(OE 82349220)

116030
(OE 21368782)

gauche - left - links



116000
(OE 82349221)



116020
(OE 21368783)

droit - right - rechts



116040
(OE 82348508)

116050
(OE 21368779)

116060
(OE 21368781)



FE07

08/2008 ->

LED

24V



207000
(OE 82116545)



207010
(OE 21087346)



207020
(OE 21087347)

SMD00

 p. 167

2001 ->

LED

 24V



198620
(OE 82392733)

Cuve blanche - cabochon PMMA
White body - PMMA lens
Weißes Gehäuse - PMMA Lichtscheibe

K



198740
(OE 84044658)

Cuve ambre - cabochon PC haute température
Amber body - PC lens high temperature
Oranges Gehäuse - PC Lichtscheibe hoch temperatur beständig



001766
(OE 85105029)

adaptateur - adaptor - adapterkabel

FH

SL18

10/2021 ->

NEW

LED

 24V

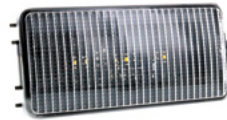

113110
(OE 24080598)

Lampe de portière
Door lamp
Türleuchte

SL08

09/2012 ->
10/2021

 5W



113000
(OE 82202076)

Lampe de portière
Door lamp
Türleuchte

FH

ATLAS

 p. 220

04/2021 ->

LED

 9/32V



212730
(OE 23742314)



TYCO MCON-2P-M

FM

LC10 LED ⓘ p. 119

09/2013 ->

LED

⚡ 24V



159500 (OE 82483074 / 84441759 / 23522307 / 23690769)
gauche - left - links



AMP 1.5-7P-M
latéral
side connector
Anschlusstecker seitlich



159530 (OE 21735299 / 84441937 / 23522305 / 23690765)
droit - right - rechts



159520 (OE 21735301 / 84441936 / 23522304 / 23690764)
gauche - left - links



159510 (OE 82483073 / 84441760 / 23522308)
droit - right - rechts



D11868 AMP 1.5-7P-F



059500 (OE 84122332)
gauche - left - links



059500 (OE 84122332)
droit - right - rechts

SRD07 ⓘ p. 155

09/2010 -> 10/2013

LED

⚡ 24V



107000 (OE 82114506 / 82355678)
gauche - left - links



107010 (OE 82114500 / 82355684)
droit - right - rechts



107040 (OE 82114504 / 21448885)
gauche - left - links



107050 (OE 82114502 / 21478751)
droit - right - rechts

11/2013 ->



107500 (OE 82467736)
gauche - left - links



107510 (OE 82467737)
droit - right - rechts

08/2008 ->



207000
(OE 82116545)



207010
(OE 21087346)



207020
(OE 21087347)

LC9

p. 135

01/2006 ->



159010
(OE 20769775)
gauche - left - links



AMP 1.5-7P-M
latéral
side connector
Anschlussstecker seitlich



159020
(OE 20769776)
droit - right - rechts



159030
(OE 20769777)
droit - right - rechts



D11868 **AMP 1.5-7P-F**



059000
(OE 20802418)
gauche - left - links



059000
(OE 20802418)
droit - right - rechts



D12953



FL - FE

LC5

 p. 137

2006 ->



152190
(OE 20769783)

gauche - left - links





AMP 1.5-7P-M
arrière
rear connector
Anschlussstecker hinten



152200
(OE 20769784)

droit - right - rechts



152880
(OE 20769781)

gauche - left - links





152880
(OE 20769782)

droit - right - rechts





D11868 **AMP 1.5-7P-F**



052000
(OE 20537280)

052500
(OE 20745060)

gauche - left - links



052000
(OE 20537280)

052500
(OE 20745060)

droit - right - rechts





ICDL94

 p. 157



119550
(OE 21341202)

JPT-3P-M



001616
(OE 20745227)



D13877 **JPT-3P-F**

FE95

 p. 162



195010
(OE 20745225)

gauche - left - links



195010
(OE 20745225)

droit - right - rechts

SH3

- * Lampe fournie
- * Bulb included
- * Inklusiv Glühlampen



D13019*
(OE 21396991)

DT-2P-M



D14170

DT-2P-F

FL

EPP98



p. 152



196010
(OE 20721495)

JPT-2P-M



D13876

JPT-2P-F

FE02



p. 162

2006 ->



102200
(OE 20717520)

Clippé - clipped - clip-befestigung

JPT-2P-M



001726
(OE 20745066)



D13876

JPT-2P-F

FPL93



p. 168



193020
(OE 20734485 / 84538758)

JPT-2P-M



001726
(OE 20745066)



D13876

JPT-2P-F



SMD98

 p.166

LED

 24V

-> 2003



198650
(OE 20480486)



JPT-2P-M



D13876

JPT-2P-F

SMD98

 p.171

LED

 24V

-> 2003



198640
(OE 70364301)



JPT-2P-M



D13876

JPT-2P-F

VOLVO CONSTRUCTION

SMD98

 p.166

LED

 24V



198520
(OE 11170068)

K

JPT-2P-M



D13876

JPT-2P-F

CHL1 H4

 p. 207

 24V
H4 - PY21 - W5W



D14320 12V

D14322 24V

gauche - left - links



DT-6P-M

arrière
rear connector
Anschlussstecker hinten



D14321 12V

D14323 24V

droit - right - rechts



D14352

DT-6P-F

TRI

 p. 184



D10596
(OE 23374865)

K

Feux arrière

Rear lamps

Heckleuchten

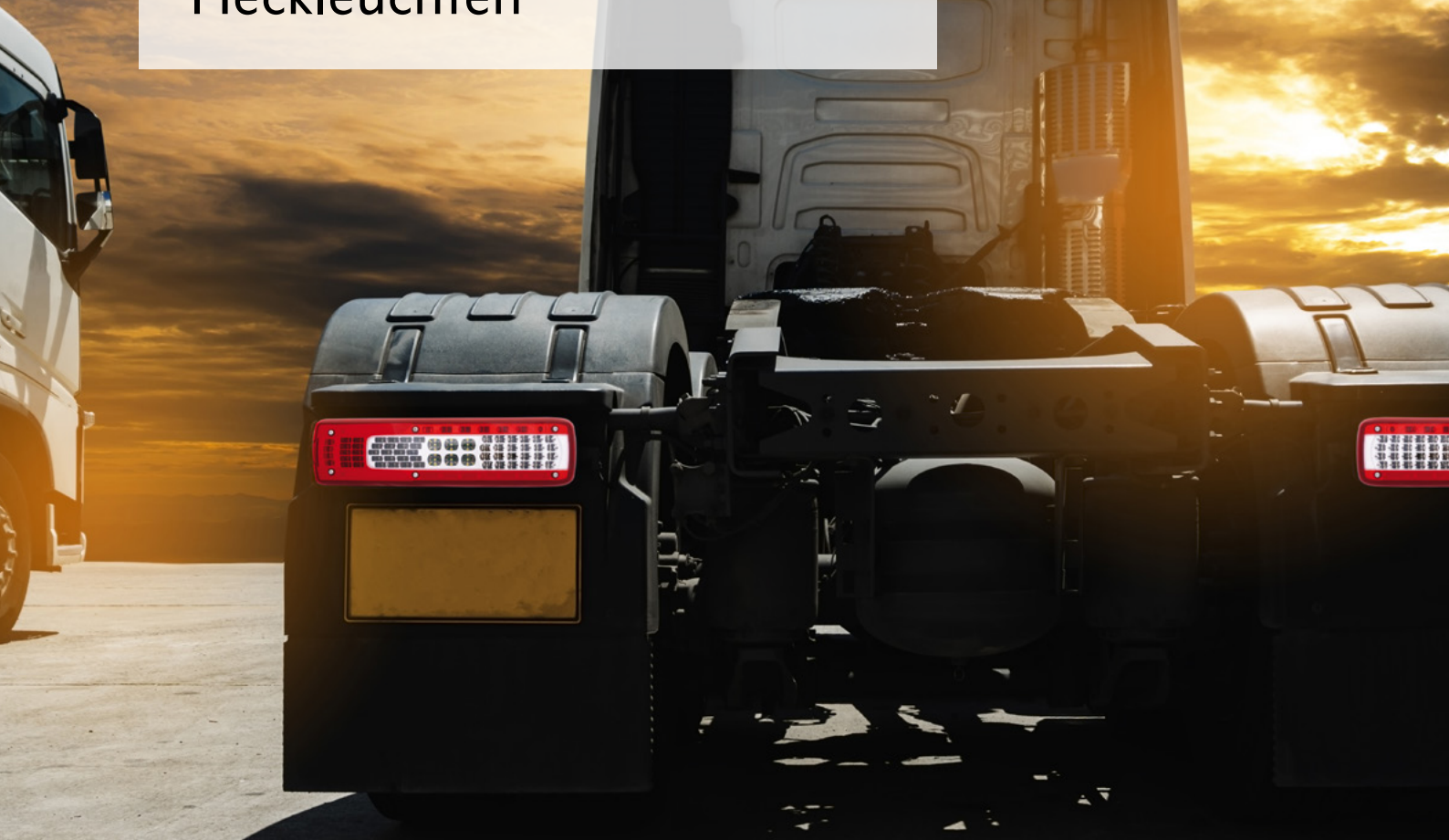

LED

p. 112-125



Halogène

p. 126-148



AMP 1.5-7P-M

Type connecteur - Nb pins - Mâle ou Femelle
Connector type - Pins Nb - Male or Female
Steckertyp - Stifte Nb - männlich oder weiblich



Faisceau p. 267
Harness p. 267
Anschlusskabel siehe S. p. 267



Flashez le QR code pour plus d'infos
Scan the QR code for more info
Scannen Sie den QR-Code für weitere Informationen



Pièces détachées
Spare parts
Ersatzteile



Numéro d'homologation
Approval number
Zulassungsnummer



Sens de montage
Mounting direction
Einbaurichtung

DETAIL CONNECTEUR 1-5	Représentation des connecteurs	FONCTION
Connecteur 1-5	1-5	FUNCTION
1	1	USURE
2	2	POSITION
3	3	STOP
4	4	INDICATEUR DE DIRECTION
5	5	STOP
6	6	INDICATEUR
7	7	NOT USED

Pinning connecteurs sur notre site web
Connectors pinning on our website
Anschlüsse feststecken auf unsere Website

Feux arrière - Rear lamps - Heckleuchten

LC12 LED

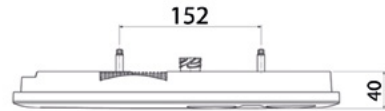
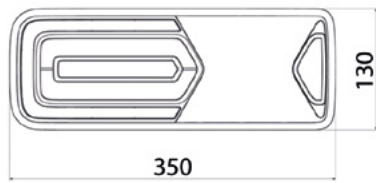

ORIGINAL



LED

ISO PULSE
13207-1

ADR



E₂ 16027
10R-0516057

Affectations constructeurs
OE applications
Fahrzeugverwendung

ALMAJDOUIE p. 8
ASCA p. 10
BENALU GROUP p. 14
DE BUF p. 25
FELDBINDER p. 27
FRUEHAUF p. 31
GROSSE EQUIPEMENT p. 33
LAMBERET p. 44
LEGINENA p. 49
MAGYAR p. 51
OMEPS p. 59
SCHMITZ p. 93
SOR IBERICA p. 95
VAK OY p. 99

GLOWING



LED

ISO PULSE
13207-1

ADR



E₂ 18042
10R-0516057



161000 24V
161200 12V
gauche - left - links



AMP 1.5-7P-M
arrière
rear connector
Anschlussstecker hinten



161010 24V
161210 12V
droit - right - rechts



161120 24V
161260 24V
161190 24V
gauche - left - links



161130 24V
161270 24V
161180 24V
droit - right - rechts



161280 24V
161420 12V
gauche - left - links



AMP 1.5-7P-M
arrière
rear connector
Anschlussstecker hinten



161290 24V
161430 12V
droit - right - rechts



161500 24V
161560 24V
161460 24V
161580 12V
gauche - left - links



161510 24V
161570 24V
161470 24V
161590 12V
droit - right - rechts



Clignotant dynamique
Dynamic indicator
Dynamischer Blinker



Feux arrière - Rear lamps - Heckleuchten

LC12 LED BLACK EDITION



NEW



AMP 1.5-7P-M
arrière
rear connector
Anschlusstecker hinten



LED ISO PULSE 13207-1

ADR

H

E2 18042
10R-0516057

161700 24V
161720 24V
gauche - left - links

161710 24V
161730 24V
droit - right - rechts

4 connecteurs pour options
4 connectors for options
4 Anschlüsse für Optionen

Position latéral clignotant
Side marker flashing lamp
Blinkende seitens markierungs leuchte

Recul
Reverse
Rückfahr

Position
Schlußlicht

Resistance intégrée (contrôle défaillance indicateur)
Integrated resistance (indicator failure control)
Integrierter widerstand (Blinkerausfallkontrolle)

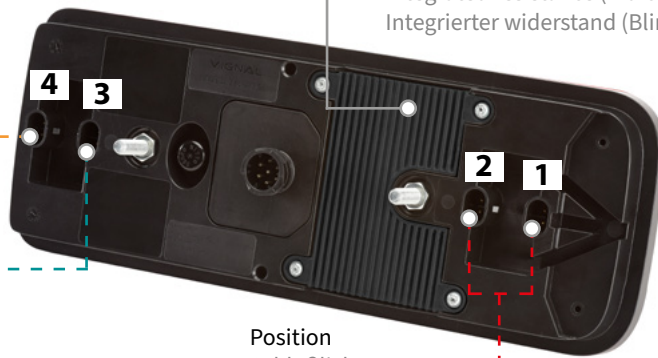

1+2+4 = 1 Amp maxi
3 = 1 Amp maxi



<p>104090 500 mm </p> <p>104100 1500 mm </p>	<p> D14857 DT-2P-M</p>	<p>199040 SS-2P-M</p>	<p>D14781 SS-2P-F</p>	<p>D14782 SS-2P-F</p>
<p>R14412 16 m SS-2P-F</p>	<p>R14413 1500 mm DT-2P-F SS-2P-F</p>	<p>D14985 1500 mm SS-2P-F</p>	<p>D14425 1500 mm SS-2P-F</p>	<p>D14426 1500 mm SS-2P-F</p>
<p>D11868 AMP 1.5-7P-F</p>	<p>R14426 1500 mm SS-2P-M SS-2P-F</p>	<p>R14418 SS-2P-M SS-2P-F</p>		

Rallonge SUPERSEAL 2 voies
2 poles SUPERSEAL extension lead
Verlängerungsschnur Anschlussstecker 2 polig

Feux arrière - Rear lamps - Heckleuchten

LCR19

GLOWING

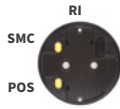
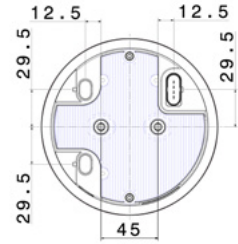
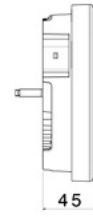
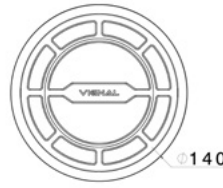

ISO PULSE
13207-1



24V

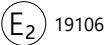

Affectations constructeurs
OE applications
Fahrzeugverwendung

BENALU GROUP p. 14
MAGYAR p. 51
OMEPS p. 59
SCHMITZ p. 93

213010

AMP MCP-4P-M

Position Glowing - Stop - Clignotant
Glowing position - Stop - Indicator
Glowing Schlusslicht - Bremslicht - Blinker

213070

AMP MCP-4P-M

Position Glowing - Stop - Clignotant
Glowing position - Stop - Indicator
Glowing Schlusslicht - Bremslicht - Blinker

213090

AMP MCP-4P-M

Position Glowing - Stop - Clignotant
Glowing position - Stop - Indicator
Glowing Schlusslicht - Bremslicht - Blinker

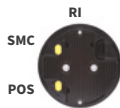

BLACK EDITION

NEW

213240

AMP MCP-4P-M

Position Glowing - Stop - Clignotant
Glowing position - Stop - Indicator
Glowing Schlusslicht - Bremslicht - Blinker

NEW

213300

AMP MCP-4P-M

Position Glowing - Stop - Clignotant
Glowing position - Stop - Indicator
Glowing Schlusslicht - Bremslicht - Blinker

R23



213150

AMP MCP-4P-M

Recul - Brouillard
Reverse - Fog
Rückfahrlicht - Nebelschlusslicht



213160

AMP MCP-4P-M

Recul - Brouillard
Reverse - Fog
Rückfahrlicht - Nebelschlusslicht



213200

AMP MCP-4P-M

Position Glowing - Recul - Brouillard
Glowing position - Reverse - Fog
Glowing Schlusslicht - Rückfahrlicht - Nebelschlusslicht

NEW

BLACK EDITION



213380

AMP MCP-4P-M

Recul - Brouillard
Reverse - Fog
Rückfahrlicht - Nebelschlusslicht

NEW



213430

AMP MCP-4P-M

Position Glowing - Recul - Brouillard
Glowing position - Reverse - Fog
Glowing Schlusslicht - Rückfahrlicht - Nebelschlusslicht



Catadioptr
Reflector
Rückstrahler



Connecteurs additionnels
Additional connectors
Zusätzliche elektrische anschlüsse

Feux arrière - Rear lamps - Heckleuchten

LCR19

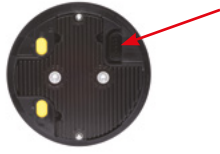

D14984

AMP-MCP-4P-F

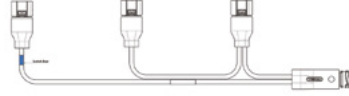

D14980

AMP-MCP-4P-F

AMP 1.5-7P-M



D14983

AMP-MCP-4P-F

AMP-MCP-4P-F

AMP-MCP-4P-F

AMP-MCP-4P-F

AMP-MCP-4P-F



D14846

HDSCS-6P-F

gauche - left - links



D14847

HDSCS-6P-F

droit - right - rechts



D14884

HDSCS-6P-F

gauche - left - links



D14885

HDSCS-6P-F

droit - right - rechts

Affectations constructeurs
OE applications
Fahrzeugverwendung

SCHMITZ p. 93

SMC
Position latéral clignotant
Side marker flashing lamp
Blinkende seiten markierungs leuchte

POS
Position
Schlußlicht

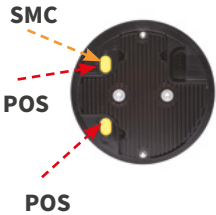

104090

500 mm

K

104100

1500 mm

K



199040

SS-2P-M



D14425

1500 mm

gauche - left - links



D14426

1500 mm

droit - right - rechts

* **SMC**
Position latéral clignotant
Side marker flashing lamp
Blinkende seiten markierungs leuchte

POS
Position
Schlußlicht

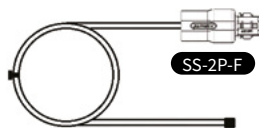

R14412

16 m



D14985

1500 mm

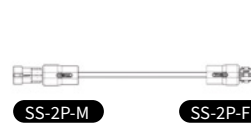

R14426

1500 mm

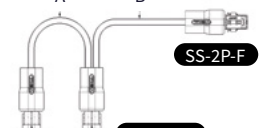

R14418

A: 300 mm / B: 500 mm

RI
Resistance intégrée (contrôle défaillance indicateur)
Integrated resistance (indicator failure control)
Integrierter widerstand (blinkleuchtenausfallkontrolle)

Rallonge SUPERSEAL 2 voies
2 poles SUPERSEAL extension lead
Verlängerungsschnur Anschlussstecker 2 polig

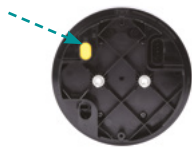

D14857

DT-2P-M

R23
Recul
Reverse
Rückfahr

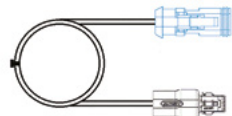

R14413

1500 mm

DT-2P-F

SS-2P-F



002100

Anneau chromé
Chrome ring
Chromring

Feux arrière - Rear lamps - Heckleuchten

LC11

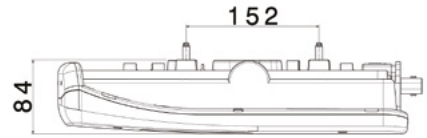
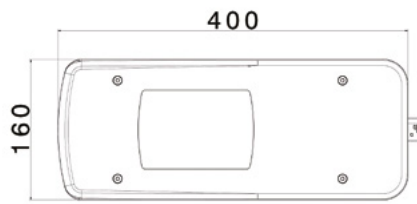

LED



ISO PULSE
13207-1



24V



14085
E₂ 14086 -FPL
10R-047585

Affectations constructeurs
OE applications
Fahrzeugverwendung

IVECO p. 34



160150

gauche - left - links



HDSCS-8P-M

latéral
side connector
Anschlusstecker seitlich



160100

droit - right - rechts



160080

gauche - left - links



160090

droit - right - rechts



160110

gauche - left - links



HDSCS-8P-M

arrière
rear connector
Anschlusstecker hinten



160130

droit - right - rechts



160140

gauche - left - links



160120

droit - right - rechts



D13878

HDSCS-8P-F



060000

gauche - left - links



060010

droit - right - rechts



Feux arrière - Rear lamps - Heckleuchten

LC11

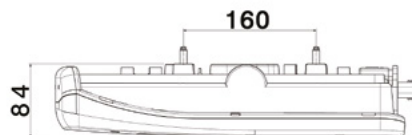
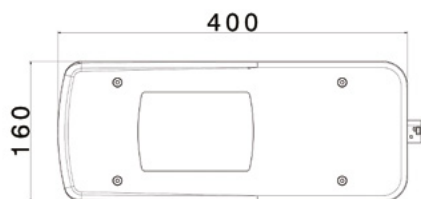

LED ISO PULSE 13207-1

12V

ADR

H

E2 14085
14086 - FPL
10R-047585

Affectations constructeurs
OE applications
Fahrzeugverwendung

MERCEDES SPRINTER p. 56



160400

gauche - left - links

K FPL EPP



AMP 1.5-7P-M
arrière
rear connector
Anschlussstecker hinten



160410

droit - right - rechts

K FPL



D11868

AMP 1.5-7P-F



060000

gauche - left - links

K



060010

droit - right - rechts

K



Feux arrière - Rear lamps - Heckleuchten

LC9 LED

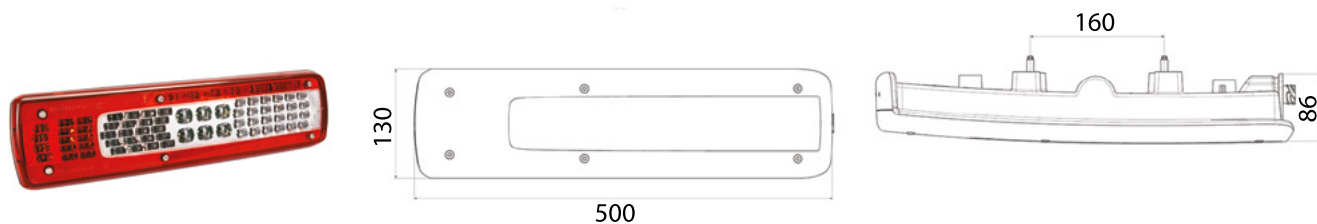

LED

24V



E2 10113
10R-036227

Affectations constructeurs
OE applications
Fahrzeugverwendung

RENAULT TRUCKS p. 63
VOLVO TRUCKS p. 101



158030

gauche - left - links



AMP 1.5-7P-M

latéral
side connector
Anschlussstecker seitlich



158050

droit - right - rechts



158040

droit - right - rechts



D11868

AMP 1.5-7P-F



058000

gauche - left - links



058000

droit - right - rechts



LC10 LED

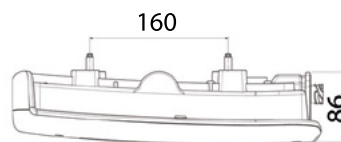
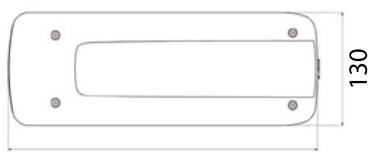

357



LED

24V



E2 12164
10R-036854

Affectations constructeurs
OE applications
Fahrzeugverwendung

RENAULT TRUCKS p. 63
VOLVO TRUCKS p. 101



159520

gauche - left - links

K FPL



AMP 1.5-7P-M

latéral
side connector
Anschlusstecker seitlich



159530

droit - right - rechts

K FPL



159500

gauche - left - links

K FPL EPP



159510

droit - right - rechts

K FPL



D11868

AMP 1.5-7P-F



059500

gauche - left - links



059500

droit - right - rechts

Feux arrière - Rear lamps - Heckleuchten

CTL15



LED

24V



E₂ 16005

Affectations constructeurs
OE applications
Fahrzeugverwendung

CHEREAU p. 17
LECAPITAINE p. 48
TROUILLET p. 97

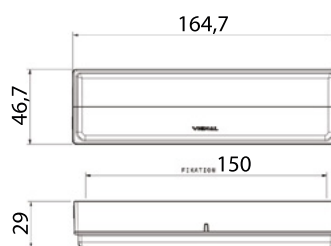
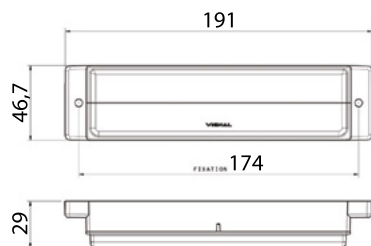

DT04-4P-M



DT04-4P-M



DTM04-4P-M



164000

Fixation par l'arrière
Back fixation
Rückenfixierung



164010

Pour raccordement sur feu BL15
To plug in BL15 lamp
Zum direkten Anschluss an die leuchte BL15



DT04-4P-M



164020

Fixation par l'avant
Front fixation
Frontfixierung



DT04-4P-M



DTM04-4P-M



164030

Pour raccordement sur feu BL15
To plug in BL15 lamp
Zum direkten Anschluss an die leuchte BL15

BL15



LED

24V

1200 Lumen



E₂ 16007
10R-0516079

Affectations constructeurs
OE applications
Fahrzeugverwendung

CHEREAU p. 17
FRUEHAUF p. 31
LECAPITAINE p. 48
TROUILLET p. 97

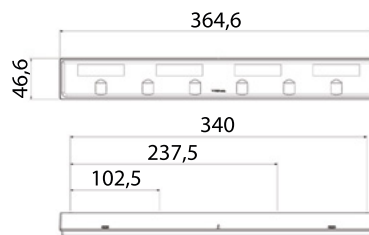
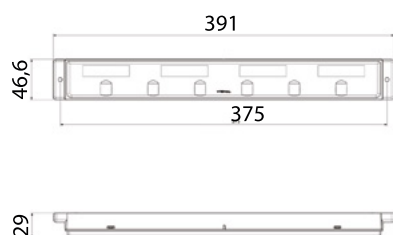

165020

gauche - left - links



DT04-4P-M



DTM06-4S-4P-F

Fixation par l'arrière
Back fixation
Rückenfixierung



165030

droit - right - rechts



165040

gauche - left - links

Fixation par l'avant
Front fixation
Frontfixierung



165050

droit - right - rechts

CTL15 - BL15

Indicateur de direction à défilement - feux de détresse flash
 Dynamic indicator lights - warning lights
 Dynamischer Blinker - Blinkende Warnleuchte



Feu de travail 1200 Lumen
 Work light 1200 Lumen
 Arbeitsscheinwerfer 1200 Lumen

Stop et position
 Stop and position
 Bremsleuchte und Schlussleuchte



CTL15 - BL15

- LED**
- 24V**
- 1200 Lumen**
- H**
- E2** 16005
16007
10R-0516079

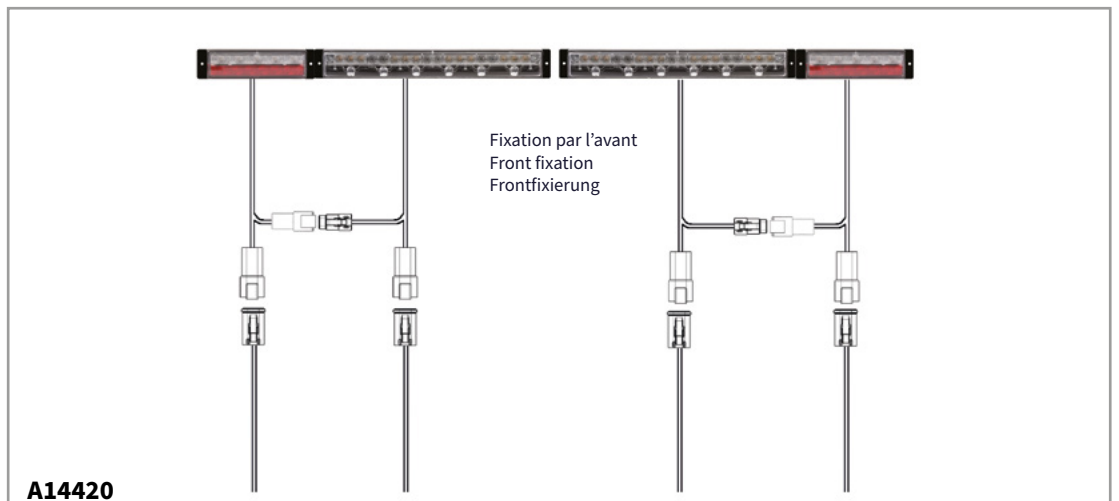

2 x CTL15 + 1 x BL15 gauche + 1 x BL15 droit + 4 câbles 8,5 m
 2 x CTL15 + 1 x left BL15 + 1 x right BL15 + 4 cables 8,5 m
 2 x CTL15 + 1 x BL15 links + 1 x BL15 rechts + 4 Verkabelung 8,5 m

Feux arrière - Rear lamps - Heckleuchten

CTL14

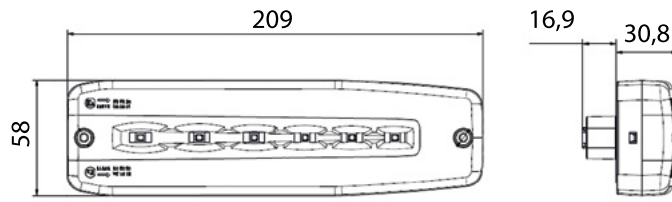

LED

ISO PULSE
13207-1



12/24V



16111
20056
10R-17254



163010

gauche/droit - left/right - links/rechts
Stop - position - clignotant dynamique
Stop - position - dynamic direction indicator
Bremsleuchte - Schlussleuchte - Dynamischer
Blinker



163050

gauche/droit - left/right - links/rechts
Stop - position - recul
Stop - position - reverse
Bremsleuchte - Schlussleuchte - Rückfahrlicht



DT04-4P-M
arrière
rear connector
Anschlussstecker hinten



D14436 DT06-4S-4P-F

SESA SOLAR

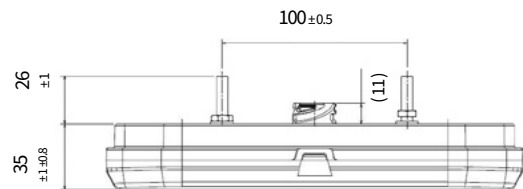
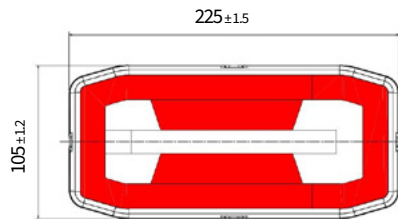

LED



12V



14261
10R-4974



IP69K

NEW



D15056
(F SMR)

gauche/droit - left/right - links/rechts
Stop - position - clignotant - recul - antibrouillard
Stop - position - direction indicator - reverse - fog
Bremsleuchte - Schlussleuchte - Blinker - Rückfahrleuchte -
Nebelschlussleuchte

K



AMP 1.5-7P-M
arrière
rear connector
Anschlussstecker hinten



Clignotant dynamique ou statique
Dynamic or static direction indicator
Dynamischer oder statischer Blinker

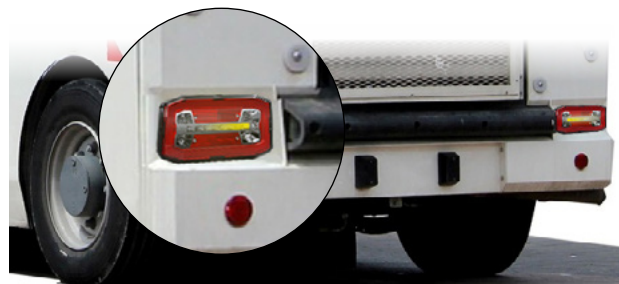

SESA AIRGLOW

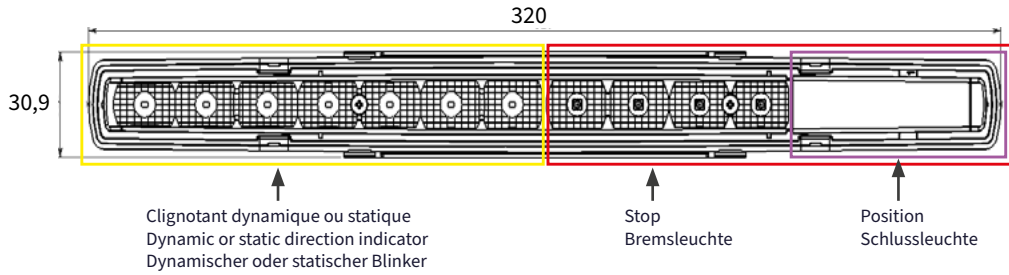

LED

12/24V



E₉ 14260
10R-4955

IP69K

NEW



D16006
(FSAG.UPSPC) **SS-5P-M**

gauche/droit - left/right - links/rechts

SLIM

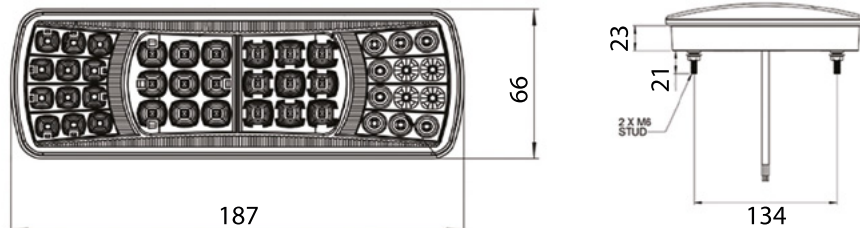

LED

12/24V



E₉ 11734
10R-051614

* fils nus - naked cable extre-
mity - Kabellitze

D13817*

gauche/droit - left/right - links/rechts



F930



NEW

LED IP67

12/24V



E₁ 3110
10R-0310354

D16011*

(F930) **K**
gauche/droit - left/right - links/rechts

* fils nus - naked cable extremity - Kabellitze

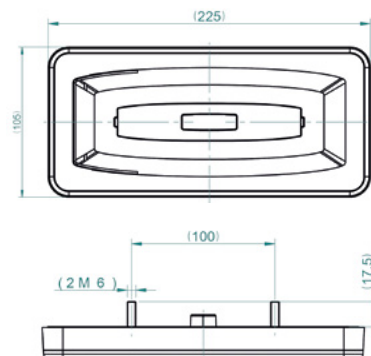

Feux arrière - Rear lamps - Heckleuchten

FRR

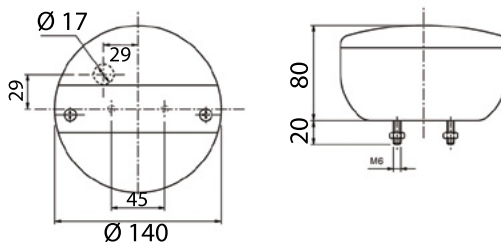

LED

12/24V



E4
13992
23271
4052



IP67

* cosses plates - flat plugs -
Flachstecker



D13816 *

gauche/droit - left/right - links/rechts
Stop - position - clignotant
Stop - position - direction indicator
Bremsleuchte - Schlussleuchte - Blinker



D14189 *

feu de recul
reverse lamp
rückfahrleuchte



D14188 *

feu de brouillard
fog lamp
nebelschlussleuchte

FRR

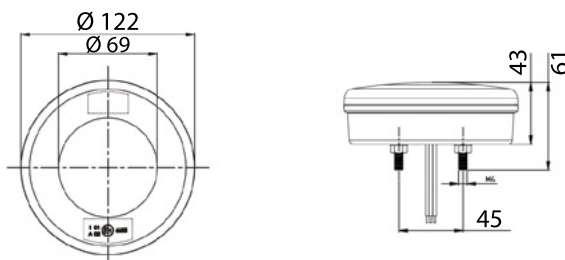

LED

12/24V



E9
6653
1288
10R-041489
10R-041487



IP67

* fils nus - naked cable extre-
mity - Kabellitze



D14348*

gauche/droit - left/right - links/rechts
Stop - position - clignotant
Stop - position - direction indicator
Bremsleuchte - Schlussleuchte - Blinker



D14345*

feu de recul - brouillard
reverse - fog lamp
rückfahrleuchte - nebelschlussleuchte

KIT WIRELESS MAGNETIC

LED

12/24V

H

IP67

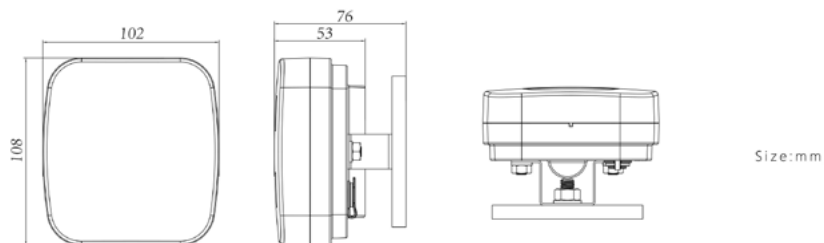

NEW



D16089
(SAR70KITEA9800W)
gauche/droit - left/right - links/rechts



2.4G
LED Wireless
Control

STOP



LED

12/24V

H

E₂₀ 0021276
10R-052819

IP67

NEW



D16029*
(66L682)
Stop - Bremsleuchte

* fils nus - naked cable extre-
mity - Kabellitze

Feux arrière - Rear lamps - Heckleuchten

LC8

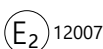
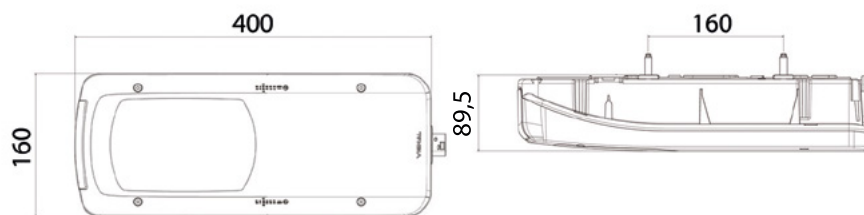

Affectations constructeurs
OE applications
Fahrzeugverwendung

DAF p. 20



155100

gauche - left - links



HDSCS-8P-M

latéral
side connector
Anschlusstecker seitlich



155110

droit - right - rechts



155120

droit - right - rechts



155130

gauche - left - links



HDSCS-8P-M

arrière
rear connector
Anschlusstecker hinten



155140

droit - right - rechts



155150

droit - right - rechts



D13878

HDSCS-8P-F



055020

gauche - left - links



055030

droit - right - rechts



001830



Feux arrière - Rear lamps - Heckleuchten

LC8

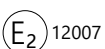
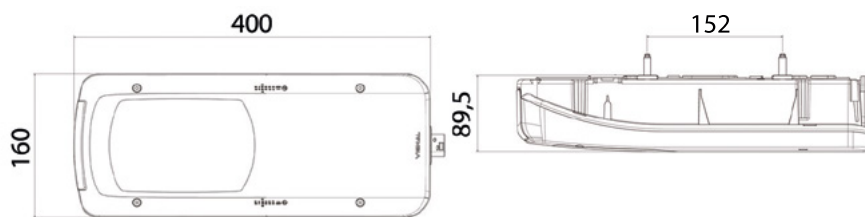

Affectations constructeurs
OE applications
Fahrzeugverwendung

VOLKSWAGEN CRAFTER p. 100



155570

gauche - left - links



AMP 1.5-7P-M
arrière
rear connector
Anschlussstecker hinten



155580

droit - right - rechts



D11868

AMP 1.5-7P-F



055020

gauche - left - links



055030

droit - right - rechts



Feux arrière - Rear lamps - Heckleuchten

LC8

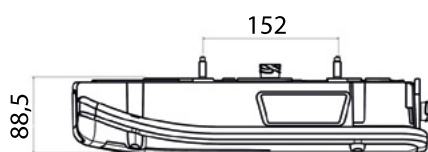
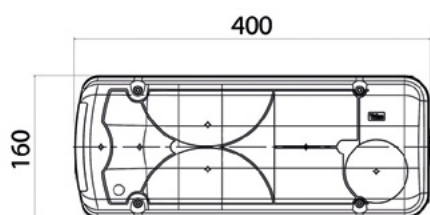

Affectations constructeurs
OE applications
Fahrzeugverwendung
IVECO p. 34

DESIGN EFFET FUMÉ - MÉTALLISÉ
SMOKED EFFECT & METTALIZED DESIGN



155450

gauche - left - links



HDSCS-8P-M

latéral
side connector
Anschlusstecker seitlich



155460

droit - right - rechts



155470

droit - right - rechts



155480

gauche - left - links



HDSCS-8P-M

arrière
rear connector
Anschlusstecker hinten



155490

droit - right - rechts



155540

gauche - left - links



155500

droit - right - rechts



D13878

HDSCS-8P-F



055040

gauche - left - links



055050

droit - right - rechts



001830



Feux arrière - Rear lamps - Heckleuchten

LC8

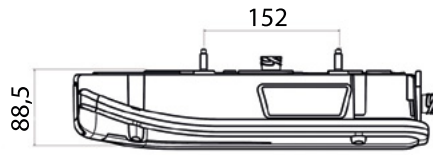
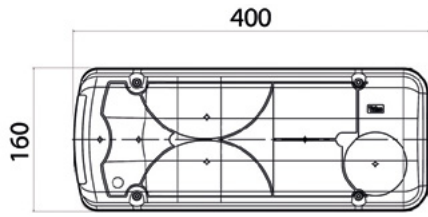

Affectations constructeurs
OE applications
Fahrzeugverwendung

MAN p. 52



156200

gauche - left - links



AMP 1.5-7P-M

latéral
side connector
Anschlusstecker seitlich



156210

droit - right - rechts



001872 55-90 db



156220

droit - right - rechts



Affectations constructeurs
OE applications
Fahrzeugverwendung

MAN (TGE) p. 52

* vis arrière de 31 mm
* 31 mm rear bolts
* hintere Schraube 31 mm



155550 *

gauche - left - links

12V



AMP 1.5-7P-M

arrière
rear connector
Anschlusstecker hinten



155560 *

droit - right - rechts

12V



D11868 AMP 1.5-7P-F

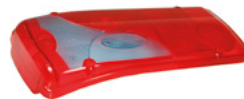

056500

gauche - left - links

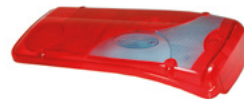

056510

droit - right - rechts



Feux arrière - Rear lamps - Heckleuchten

LC8

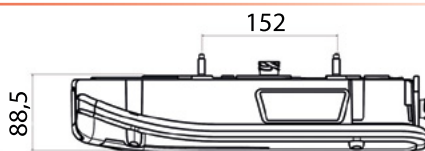
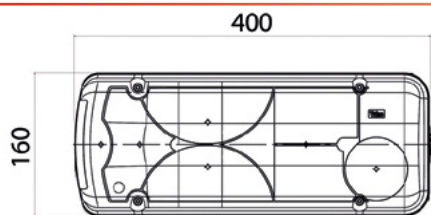

Affectations constructeurs
OE applications
Fahrzeugverwendung
[CHEREAU p. 17](#)
[LAMBERET p. 44](#)



156550

gauche - left - links



AMP 1.5-7P-M

arrière
rear connector
Anschlussstecker hinten

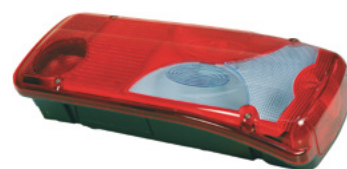

156540

droit - right - rechts



156310

gauche - left - links

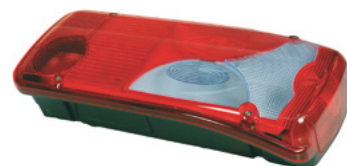

156300

droit - right - rechts



156290

gauche - left - links



D11868

AMP 1.5-7P-F



056000

056500

gauche - left - links



056010

056510

droit - right - rechts



Feux arrière - Rear lamps - Heckleuchten

LC8

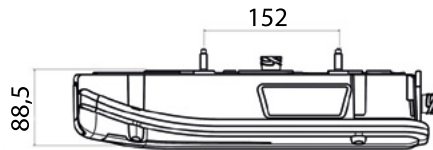
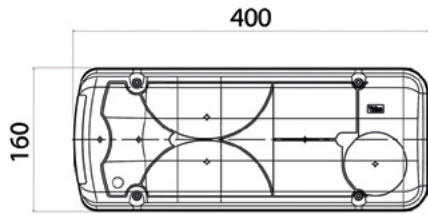

Affectations constructeurs
OE applications
Fahrzeugverwendung

SCANIA p. 91



156770

gauche - left - links



AMP 1.5-7P-M

latéral
side connector
Anschlusstecker seitlich



156780

droit - right - rechts



155020

gauche - left - links



156790

droit - right - rechts



155080

gauche - left - links



AMP 1.5-7P-M

arrière
rear connector
Anschlusstecker hinten



155520

droit - right - rechts



155090

droit - right - rechts



D11868

AMP 1.5-7P-F



056540

gauche - left - links



056550

droit - right - rechts



001830



Feux arrière - Rear lamps - Heckleuchten

LC8

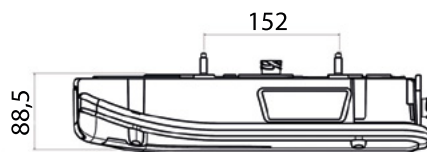
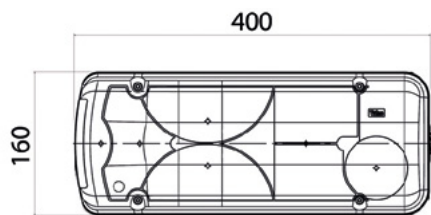

Affectations constructeurs
OE applications
Fahrzeugverwendung

MERCEDES p. 55
VOLKSWAGEN p. 100



156590

gauche - left - links



AMP 1.5-7P-M

arrière
rear connector
Anschlussstecker hinten



156600

droit - right - rechts



156340

gauche - left - links



156350

droit - right - rechts



D11868

AMP 1.5-7P-F



056020

056540

gauche - left - links



056030

056550

droit - right - rechts



LC8T

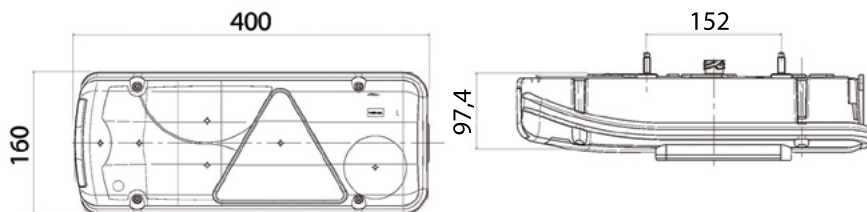

Affectations constructeurs
OE applications
Fahrzeugverwendung

- ALMAJDOUIE p. 8
- ASCA p. 10
- BENALU GROUP p. 14
- CHEREAU p. 17
- FRUEHAUF p. 31
- LAMBERET p. 44
- SOR IBERICA p. 95



156040
gauche - left - links



AMP 1.5-7P-M
arrière
rear connector
Anschlussstecker hinten



156050
droit - right - rechts



156060
gauche - left - links



156070
droit - right - rechts



Repiquage fonctions stop et positions Plug-in stop and positions Anschluss zusätzliche Brems und Positionsleuchten

Pour - For - Für :
156040 - 156050 - 156060 - 156070 - 156130 - 156170
- 156250 - 156260 156290 - 156300 - 156310 - 156380 -
156390 - 156540 - 156550 - 156590 156600
Câblage - Harness - Anschlusskabel p. 270



156130
droit - right - rechts



156630
gauche - left - links



AMP 1.5-7P-M
latéral
side connector
Anschlussstecker seitlich



156640
droit - right - rechts



D11868 **AMP 1.5-7P-F**



056700
gauche - left - links



056710
droit - right - rechts



001830

Feux arrière - Rear lamps - Heckleuchten

LC8T

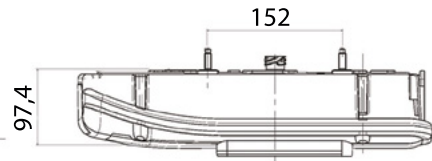
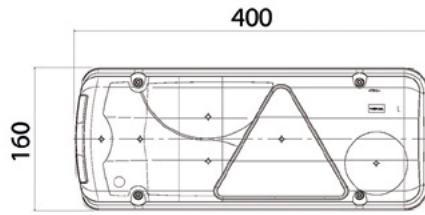

Affectations constructeurs
OE applications
Fahrzeugverwendung

FELDBINDER p. 27
LECIENNA p. 49



156250

gauche - left - links



AMP 1.5-7P-M

arrière
rear connector
Anschlussstecker hinten



156260

droit - right - rechts



156380

gauche - left - links



156390

droit - right - rechts



D11868

AMP 1.5-7P-F



056720

gauche - left - links



056730

droit - right - rechts



12/24V



D14038

500 mm

gauche - left - links

CLICK-IN



D14037

500 mm

droit - right - rechts

CLICK-IN



D14039

350 mm

gauche - left - links

POS-2P-F



D14040

350 mm

droit - right - rechts

POS-2P-F



W5W



12/24V



D13034

500 mm

gauche - left - links

CLICK-IN



D13035

500 mm

droit - right - rechts

CLICK-IN



D12712

350 mm

gauche - left - links

POS-2P-F



D12711

350 mm

droit - right - rechts

POS-2P-F



Catadioptr
Reflector
Rückstrahler



Catadioptr triangulaire
Triangular reflector
Dreieckrückstrahler



Feu de position latérale
Side marker lamp
seitenmarkierungsleuchte



Eclairer de plaque
Number plate lamp
Kennzeichenleuchte



Alarme sonore de recul
Back up alarm
Rückfahrtsignalhorn

Feux arrière - Rear lamps - Heckleuchten

LC9

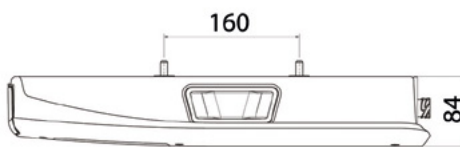
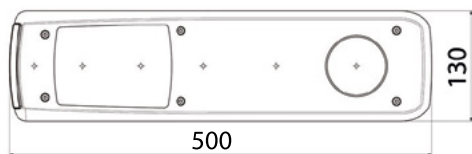

E₂ 04075

Affectations constructeurs
OE applications
Fahrzeugverwendung

RENAULT TRUCKS p. 63
VOLVO TRUCKS p. 101



159010

gauche - left - links



AMP 1.5-7P-M

latéral
side connector
Anschlussstecker seitlich



159020

droit - right - rechts



159030

droit - right - rechts



D11868

AMP 1.5-7P-F



059000

gauche - left - links



059000

droit - right - rechts



D12953



Feux arrière - Rear lamps - Heckleuchten

LC15

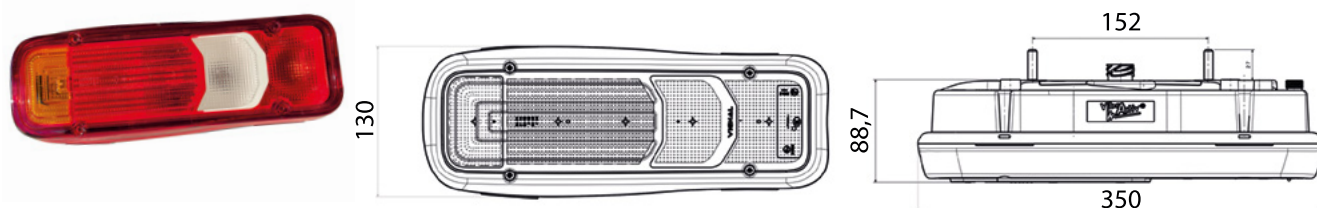

E₂ 21003

Affectations constructeurs
OE applications
Fahrzeugverwendung

IVECO p. 41

NEW



154200

gauche - left - links



AMP 1.5-7P-M

arrière
rear connector
Anschlussstecker hinten

NEW



154210

droit - right - rechts



NEW



154220

gauche - left - links



NEW



154220

droit - right - rechts



D11868

AMP 1.5-7P-F



053730

gauche - left - links



053730

droit - right - rechts



Feux arrière - Rear lamps - Heckleuchten

LC5

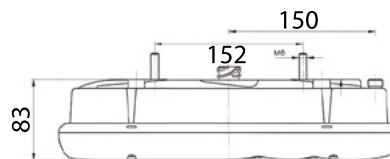
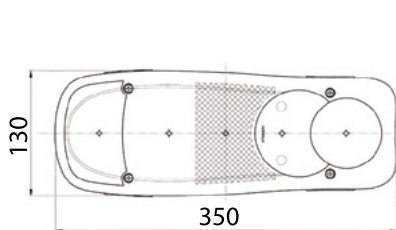

E₂ 8005

Affectations constructeurs
OE applications
Fahrzeugverwendung

DAF p. 20
IVECO p. 34
NISSAN p. 58
OPEL p. 61
RENAULT TRUCKS p. 63
VOLKSWAGEN p. 100
VOLVO TRUCKS p. 101



152130

152150

gauche - left - links



PG 13

arrière
rear connector
Anschlussstecker hinten



152130

152150

droit - right - rechts



152160

152140

gauche - left - links



AMP 1.5-7P-M

arrière
rear connector
Anschlussstecker hinten



152200

152180

droit - right - rechts



152200

152180

gauche - left - links



152190

152170

gauche - left - links



153120

droit - right - rechts



D11868

AMP 1.5-7P-F



052000

052500

gauche - left - links



052000

052500

droit - right - rechts



D13288

grille de protection réversible
homologuée - homologated
protective grid - Schutzgitter
genehmigt

Feux arrière - Rear lamps - Heckleuchten

LC5

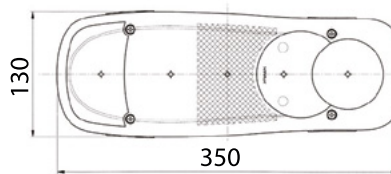

E₂ 8005

Affectations constructeurs
OE applications
Fahrzeugverwendung

FIAT p. 29
PEUGEOT CITROËN p. 62



153270

gauche - left - links



AMP 1.5-7P-M

arrière
rear connector
Anschlussstecker hinten



153280

droit - right - rechts



D11868

AMP 1.5-7P-F



052500

gauche - left - links



052500

droit - right - rechts



Fixation 4 vis M6 (190x60mm)
Fixing 4 screws M6 (190x60mm)
Befestigung 4 Schrauben M6 (190x60mm)



Feux arrière - Rear lamps - Heckleuchten

LC5

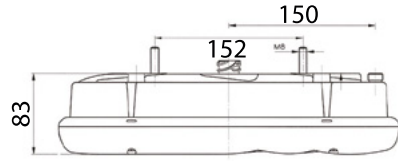
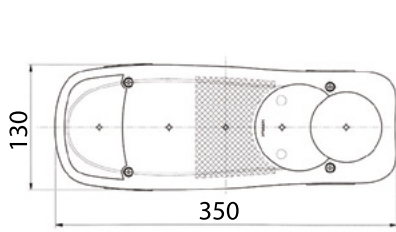

Affectations constructeurs
OE applications
Fahrzeugverwendung

IVECO p. 36



153220 K
gauche - left - links



AMP 1.5-7P-M
arrière
rear connector
Anschlussstecker hinten



153210 K
droit - right - rechts



153200 K EPP
gauche - left - links



153230 K Speaker icon
droit - right - rechts



153240 K
gauche - left - links



153250 K
droit - right - rechts

153260 K Speaker icon
droit - right - rechts



D11868 **AMP 1.5-7P-F**



052500 K
gauche - left - links



052500 K
droit - right - rechts

Feux arrière - Rear lamps - Heckleuchten

LC5T

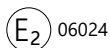
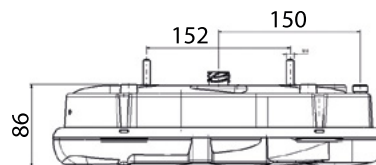
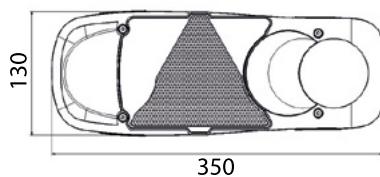

Affectations constructeurs
OE applications
Fahrzeugverwendung

ASCA p. 8
LAMBERET p. 44
LECIÑENA p. 49



153040

gauche - left - links



PG 13

arrière
rear connector
Anschlusstecker hinten



153050

droit - right - rechts



153060

gauche - left - links



153070

droit - right - rechts



153000

gauche - left - links



AMP 1.5-7P-M

arrière
rear connector
Anschlusstecker hinten



153010

droit - right - rechts



153130

droit - right - rechts



153020

gauche - left - links



153030

droit - right - rechts



D11868

AMP 1.5-7P-F

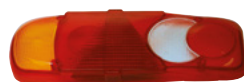

053700

gauche - left - links

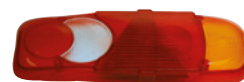

053710

droit - right - rechts



Feux arrière - Rear lamps - Heckleuchten

LC5TDX

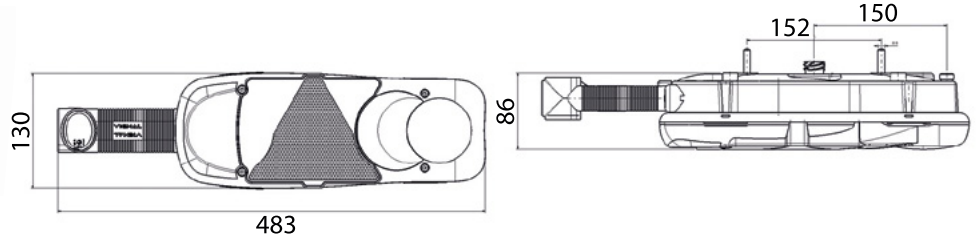

E₂ 06024 (sans DX)
07092 (avec DX)

Affectations constructeurs
OE applications
Fahrzeugverwendung

ASCA p. 10



AMP 1.5-7P-M
arrière
rear connector
Anschlusstecker hinten



153660



153700



gauche - left - links

153670



153710



droit - right - rechts



D11868

AMP 1.5-7P-F



053700



gauche - left - links



053710



droit - right - rechts



D12430

LC7

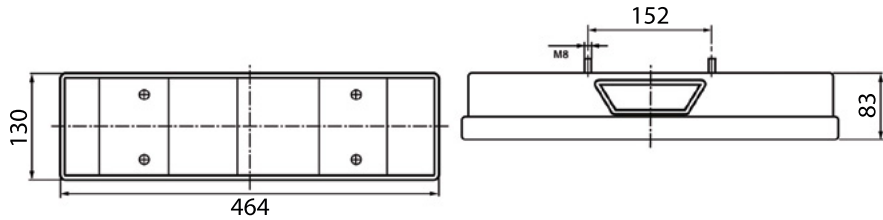

E₂ 88035 (LC7K)

Affectations constructeurs
OE applications
Fahrzeugverwendung

MAN p. 54



DIN 72480-8P-M
arrière
rear connector
Anschlusstecker hinten



168090



gauche - left - links

168090



droit - right - rechts



168100



gauche - left - links



067500



gauche - left - links



067500



droit - right - rechts

Feux arrière - Rear lamps - Heckleuchten

LC7

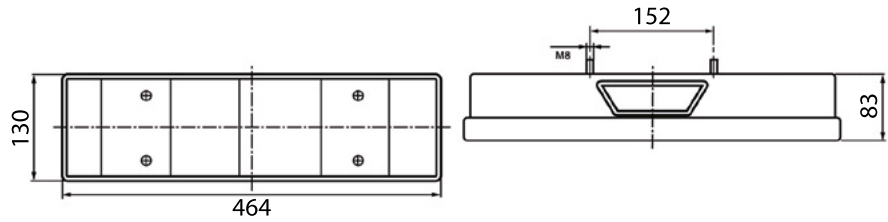

E2 88017 (LC7)
88035 (LC7K)

Affectations constructeurs
OE applications
Fahrzeugverwendung

RENAULT TRUCKS p. 68



167100

EPP

167600

K

EPP

gauche - left - links



PE
arrière
rear connector
Anschlussstecker hinten



167000

167500

K

droit - right - rechts



168270

K

FPL

gauche - left - links



168270

K

FPL

droit - right - rechts



168340

K

FPL

EPP

gauche - left - links



067000

067500

gauche - left - links



067000

067500

droit - right - rechts

Affectations constructeurs
OE applications
Fahrzeugverwendung

DAF p. 20
MAN p. 52



169180

K

FPL

gauche - left - links



AMP 1.5-7P-M

latéral
side connector
Anschlussstecker seitlich



169170

K

FPL

169190

K

FPL

Al

droit - right - rechts



169160

K

FPL

EPP

gauche - left - links



D11868

AMP 1.5-7P-F



Feux arrière - Rear lamps - Heckleuchten

LC7

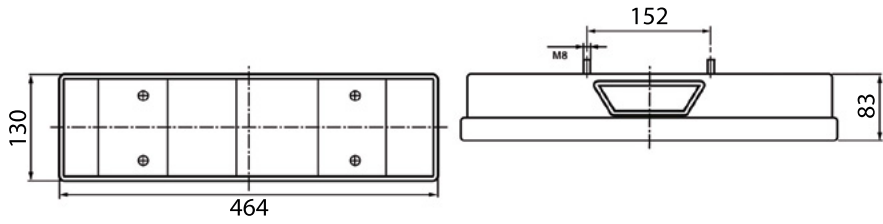

E2 88035 (LC7K)

Affectations constructeurs
OE applications
Fahrzeugverwendung

IVECO p. 38

EURO 5



168590

gauche - left - links



IVECO
arrière
rear connector
Anschlusstecker hinten



168600

droit - right - rechts



168610

gauche - left - links



168480

droit - right - rechts



Affectations constructeurs
OE applications
Fahrzeugverwendung

IVECO p. 37

EURO 6



169390

gauche - left - links



DIN 72480-8P-M
arrière
rear connector
Anschlusstecker hinten



169410

droit - right - rechts



169400

gauche - left - links



169420

droit - right - rechts



067500

gauche - left - links



067500

droit - right - rechts



D12953



Feux arrière - Rear lamps - Heckleuchten

LC7

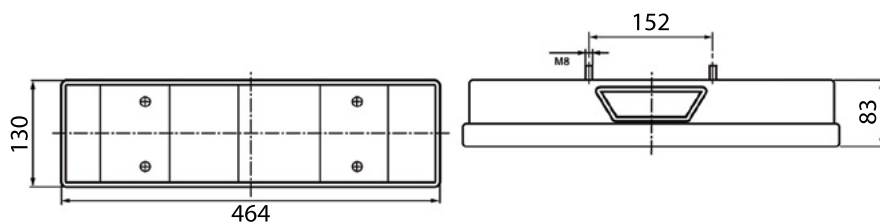

E₂ 88035 (LC7K)

Affectations constructeurs
OE applications
Fahrzeugverwendung

DAF p. 20



168020



gauche - left - links



DAF
arrière
rear connector
Anschlusstecker hinten



168010



droit - right - rechts



067500



gauche - left - links



067500



droit - right - rechts

LC7

MILITARY



168810



gauche - left - links

15P-M
arrière
rear connector
Anschlusstecker hinten



168810



droit - right - rechts

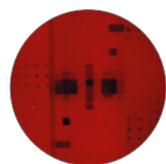

Blackout position + stop

Feux arrière - Rear lamps - Heckleuchten

LC7T

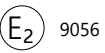
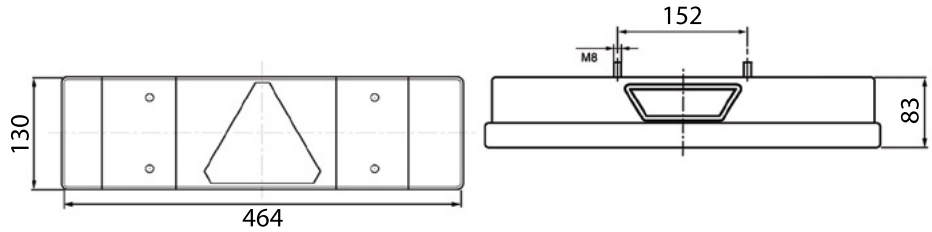

167530



168770



gauche - left - links



PE
arrière
rear connector
Anschlussstecker hinten



167550



168790



droit - right - rechts



168780



gauche - left - links



168800



droit - right - rechts



067610



gauche - left - links



067600



droit - right - rechts



168830



droit - right - rechts

LC6

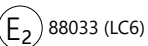
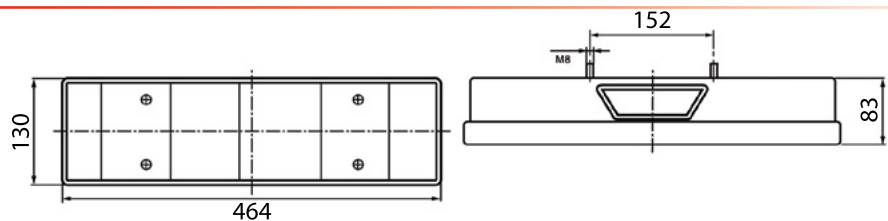

166000

166100



gauche - left - links



PE
arrière
rear connector
Anschlussstecker hinten



166000

166100



droit - right - rechts



066000

gauche - left - links



066000

droit - right - rechts

Affectations constructeurs
OE applications
Fahrzeugverwendung

RENAULT TRUCKS p. 63

Feux arrière - Rear lamps - Heckleuchten

LC4

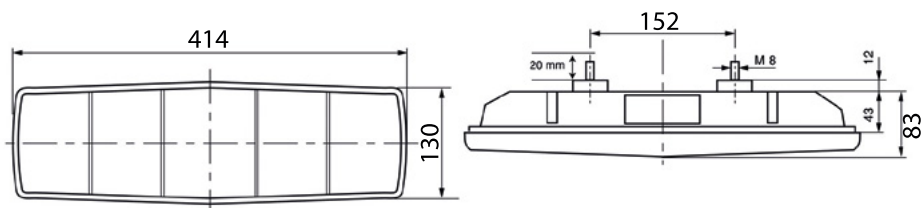

E₂ 91098 (LC4)
91099 (LC4K)

Affectations constructeurs
OE applications
Fahrzeugverwendung

RENAULT TRUCKS p. 75



141000

gauche - left - links



PE
arrière
rear connector
Anschlusstecker hinten



141000

droit - right - rechts



141500

gauche - left - links



141500

droit - right - rechts



040000

040500

gauche - left - links



040000

040500

droit - right - rechts



UNISTOP



E9 11004

Affectations constructeurs
OE applications
Fahrzeugverwendung

FORD p. 30

* fils nus - naked cable extre-
mity - Kabellitze

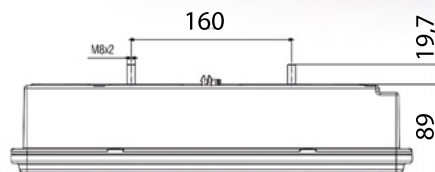
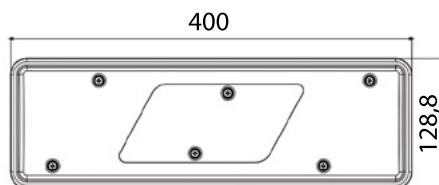

NEW



D16109*

gauche - left - links



NEW



D16108*

droit - right - rechts



WARNING SIGNAL



1710
1711
E20 10R-4184
10R-4185



IP67

* fils nus - naked cable extre-
mity - Kabellitze

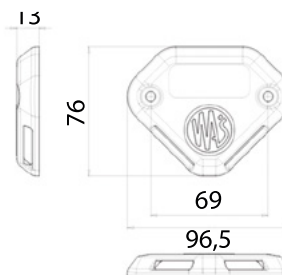
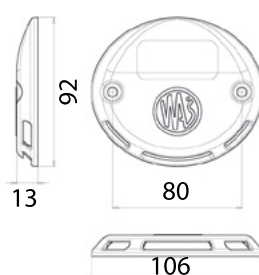

NEW



D16024

(66L1126)

NEW



D16025

(66L1127)



Feux arrière - Rear lamps - Heckleuchten

725



E13 8434

Affectations constructeurs
OE applications
Fahrzeugverwendung

IVECO p. 42

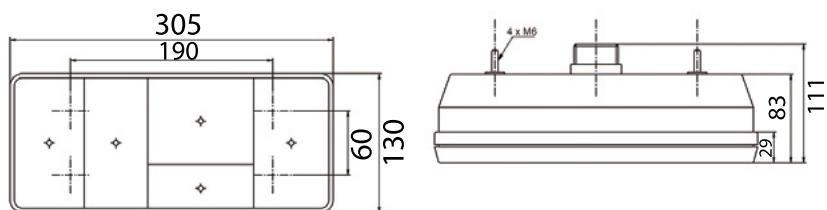

D11482

gauche - left - links



AMP 1.5-5P-M

arrière
rear connector
Anschlussstecker hinten



D11481

droit - right - rechts



D11868

AMP 1.5-7P-F



D11480

gauche - left - links



D11479

droit - right - rechts



E13 2060

Affectations constructeurs
OE applications
Fahrzeugverwendung

IVECO p. 41



D12334

gauche - left - links



AMP 1.5-6P-M

arrière
rear connector
Anschlussstecker hinten



D12335

droit - right - rechts



D11868

AMP 1.5-7P-F



D12336

gauche - left - links



D12337

droit - right - rechts



Eclaireur de plaque Number plate lamps Kennzeichenleuchten

WWW.VIGNAL-GROUP.COM

LED p. 150-151



Halogène p. 152



SS-2P-F

Type connecteur - Nb pins - Mâle ou Femelle
Connector type - Pins Nb - Male or Female
Steckertyp - Stifte Nb - männlich oder weiblich



Faisceau p. 269
Harness p. 269
Anschlusskabel siehe S. p. 269



Flashez le QR code pour plus d'infos
Scan the QR code for more info
Scannen Sie den QR-Code für weitere Informationen



Pièces détachées
Spare parts
Ersatzteile



Numéro d'homologation
Approval number
Zulassungsnummer



Sens de montage
Mounting direction
Einbaurichtung

LPL18

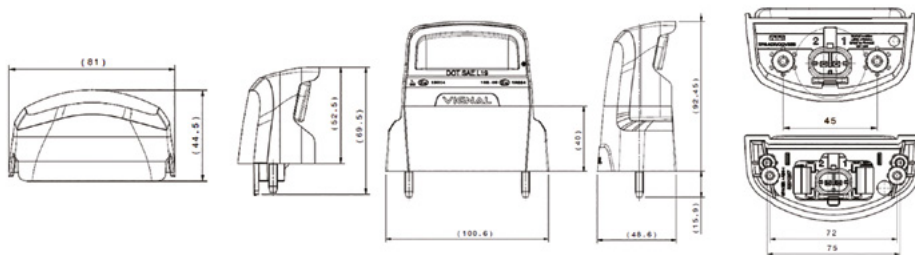

12/24V



E2 19014
10R-19224



IP6K9K



199020

SS-2P-M

Entraxe 72 mm
Bolt distance 72 mm
Befestigungsmittabstand 72 mm



199030

SS-2P-M

Entraxe 75 mm
Bolt distance 75 mm
Befestigungsmittabstand 75 mm

1 seul feu LED par plaque
1 LED lamp per plate
1 LED-Licht pro Platte



199020
199030

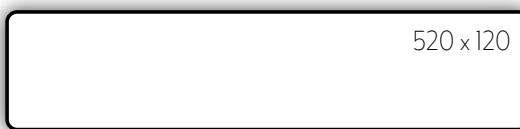

Affectations constructeurs
OE applications
Fahrzeugverwendung

ALAMJDOUIE p.8
BENALU GROUP p. 14
LAMBERET p. 44
VAK OY p. 99



199000

SS-2P-M

clippé - clipped - clip-befestigung



199040

SS-2P-M

Entraxe 45 mm
Bolt distance 45 mm
Befestigungsmittabstand 45 mm

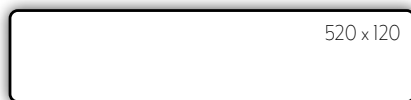

520 x 120

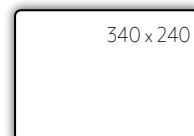

340 x 240

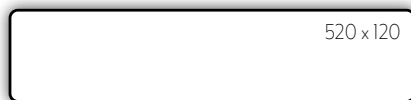

520 x 120

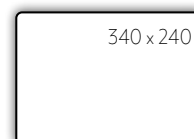

340 x 240

Plus d'implantations sur
notre site web.
More positioning on our
website.
Mehr Positionierung auf
unserer Website.



D13880

SS-2P-F



D14985

SS-2P-F



Eclaireurs de plaque - Number plate lamps - Kennzeichenleuchten

EPP96 LED



LED

24V

ADR



E₂ 11017

Affectations constructeurs
OE applications
Fahrzeugverwendung

ASCA p. 10
DE BUF p. 25
FRUEHAUF p. 31
GROSSE EQUIPEMENT p. 33
LAMBERET p. 44
OMEPS p. 59
SOR IBERICA p. 95

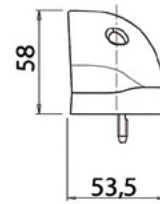
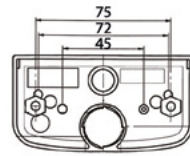
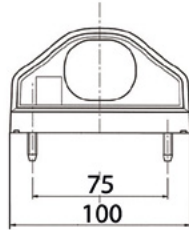

D13609 400 mm

D13610 1500 mm



R14364 2000 mm

2V Superseal
Pour / For / Für LC12T



D13874 2000 mm

2 voies - 2 poles - 2 polig
Pour / For / Für LC8



BX868



LED

12/24V

E₁₃ 10989

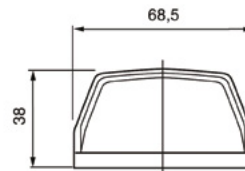
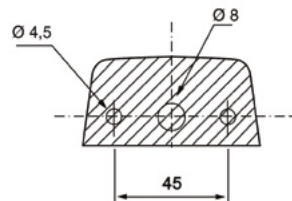

D14116 300 mm

Eclaireurs de plaque - Number plate lamps - Kennzeichenleuchten

EPP96/98

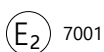

Affectations constructeurs
OE applications
Fahrzeugverwendung

- ASCA p. 10
- CHEREAU p. 17
- FRUEHAUF p. 31
- LAMBERET p. 44
- MERCEDES p. 55
- RENAULT TRUCKS p. 63
- SOR IBERICA p. 95

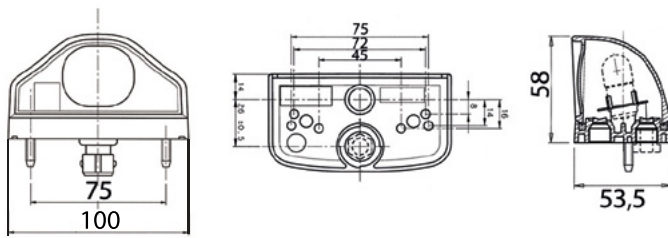

196020



000176

Affectations constructeurs
OE applications
Fahrzeugverwendung

- DAF p. 20
- OPEL p. 61
- RENAULT TRUCKS p. 63
- UD TRUCKS p. 98
- VOLVO TRUCKS p. 100



CLICK-IN

D10502

410 mm

D11888

1000 mm



HDSCS-3P-M

196170

500 mm



POS-2P-F

D10227

700 mm

2 voies - 2 poles - 2 polig
Pour / For / Für LC8



Affectations constructeurs
OE applications
Fahrzeugverwendung

- DAF p. 20
- OPEL p. 61
- RENAULT TRUCKS p. 63
- UD TRUCKS p. 98
- VOLVO TRUCKS p. 100



196010

JPT-2P-M



D13876

JPT-2P-F



280009

JPT-2P-F

2 m

2751

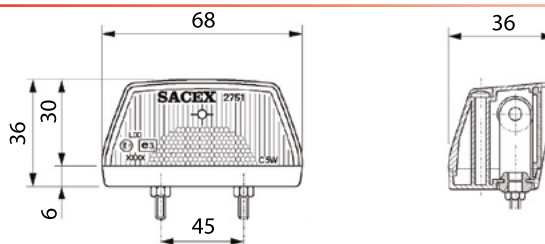

D14517

(27.51.090.VLG)

Feux clignotants

Flasher lamps

Fahrtrichtungsanzeiger

Face avant - Front face - Frontansicht

p. 154



Face latérale - Side face - Seitenansicht

p. 155-158

JPT-2P-F

Type connecteur - Nb pins - Mâle ou Femelle
Connector type - Pins Nb - Male or Female
Steckertyp - Stifte Nb - männlich oder weiblich



Flashez le QR code pour plus d'infos
Scan the QR code for more info
Scannen Sie den QR-Code für weitere Informationen



Pièces détachées
Spare parts
Ersatzteile



Numéro d'homologation
Approval number
Zulassungsnummer

Feux clignotants - Flasher lamps - Fahrtrichtungsanzeiger

C105



P21W



06018
12056

Affectations constructeurs
OE applications
Fahrzeugverwendung

IVECO p. 34



PY21W



110520

gauche - left - links

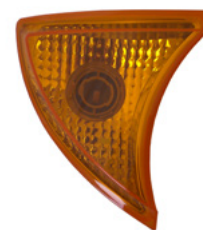

110530

droit - right - rechts



110550

gauche - left - links



110560

droit - right - rechts



001619

C199



PY21W



0050

Affectations constructeurs
OE applications
Fahrzeugverwendung

IVECO p. 34

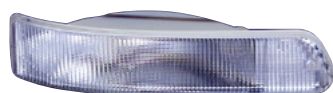

119920

gauche - left - links



119930

droit - right - rechts

FLASHER UNIT



014580

Renault 5010149149
5 lampes, centrale clignotante
5 lamps, flasher unit
5 Glühlampen, Blinkereinheit



SRD08



LED

⚡ 24V

E₂ 10073

Affectations constructeurs
OE applications
Fahrzeugverwendung

VOLVO TRUCKS p. 101



111000

gauche - left - links



111010

droit - right - rechts



111020

gauche - left - links



111030

droit - right - rechts

SRD07



LED

⚡ 24V

E₂ 08028

Affectations constructeurs
OE applications
Fahrzeugverwendung

VOLVO TRUCKS p. 101



107000

gauche - left - links



107010

droit - right - rechts



107040

gauche - left - links



107050

droit - right - rechts



107500

gauche - left - links



107510

droit - right - rechts

ICDL15



P21W



16059



120000

Affectations constructeurs
OE applications
Fahrzeugverwendung

[UD TRUCKS p. 98](#)

ICDL10



PY21W



11128



117000

gauche - left - links



117010

droit - right - rechts

Affectations constructeurs
OE applications
Fahrzeugverwendung

[DAF p. 20](#)



001619

ICDL07



PY21W



09025



109010

Affectations constructeurs
OE applications
Fahrzeugverwendung

[DAF p. 20](#)



ICDL94



E₂ 5047 (R5W)
7139 (P21W)

Affectations constructeurs
OE applications
Fahrzeugverwendung

DAF p. 20
IVECO p. 34
NISSAN p. 58
RENAULT TRUCKS p. 63
VOLVO TRUCKS p. 101

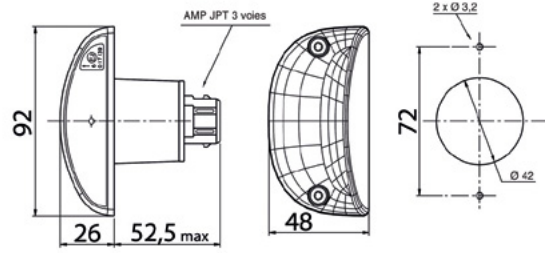

R5W

119450



119550



P21W

119470



D13877

JPT-2P-F



001616

JPT-2P-M

Feux clignotants - Flasher lamps - Fahrtrichtungsanzeiger

FE87



C5W



4703

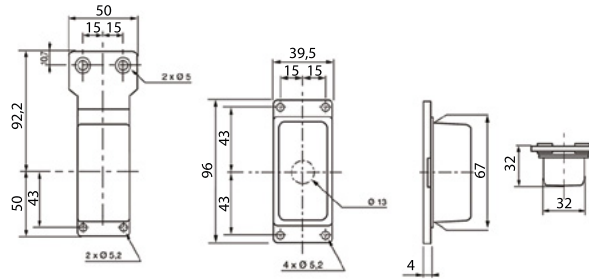

187140



187760



087040

cabochon - lens - Lichtscheibe

FE81



T4W



90711

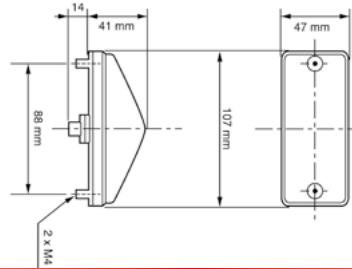

181050



000086

Feux de position

Position lamps

Positionsleuchten



Face avant - Front face - Frontansicht
p. 160-164

Face latérale - Side face - Seitenansicht
p. 165-169

Face arrière - Rear face - Heckansicht
p. 170-172



Flashez le QR code pour plus d'infos
Scan the QR code for more info
Scannen Sie den QR-Code für weitere Informationen



Pièces détachées
Spare parts
Ersatzteile



Numéro d'homologation
Approval number
Zulassungsnummer



Sens de montage
Mounting direction
Einbaurichtung

DT-2P-M

Type connecteur - Nb pins - Mâle ou Femelle
Connector type - Pins Nb - Male or Female
Steckertyp - Stifte Nb - männlich oder weiblich



Faisceau p. 268
Harness p. 268
Anschlusskabel siehe S. 268

Feux de position - Position lamps - Positionsleuchten

SMD04

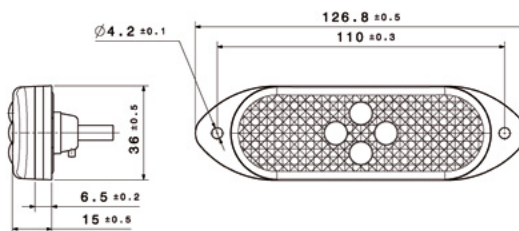

LED

24V

ADR



E₂ 05022



104130 500 mm **K**

104140 1500 mm **K**

CLICK-IN

104520 1000 mm **K**

adhésif - adhesive - selbstklebend **CLICK-IN**

104690 1000 mm **K**

SS-2P-M

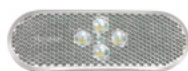

NEW **104840** 12V **K**

104720 24V **K**

SS-2P-M

FE04

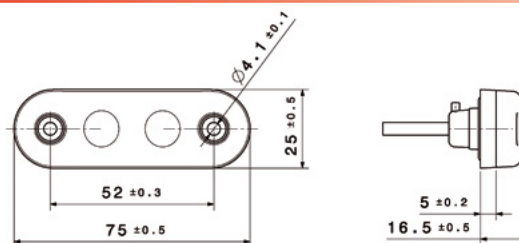

LED

24V

ADR



E₂ 05010
SAE P2

Affectations constructeurs
OE applications
Fahrzeugverwendung

ASCA p. 10
LAMBERET p. 44
RENAULT TRUCKS p. 63



104290 500 mm

104300 1500 mm

104310 5000 mm



D10132 200 mm

CLICK-IN



104570 300 mm

DT-2P-M



104450 300 mm

DT-2P-M



D14170

DT-2P-F

Feux de position - Position lamps - Positionsleuchten

SMD98



LED

12V
ou-or-oder
24V

ADR



E₂ 04010

p. 166

p. 171

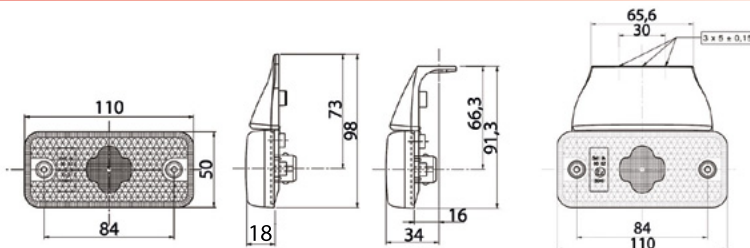

198690	12V	D10500	24V
198660	24V	D11399	24V
	JPT-2P-M	500 mm	24V
		1500 mm	D13710
			1000 mm
			POS-2P-F
			2 voies - 2 poles - 2 polig Pour / For / Für LC8
			CLICK-IN

D13876	001696	001716
JPT-2P-F		

FE94



T4W

12/24V

ADR



E₂ 4089

p. 161

p. 171

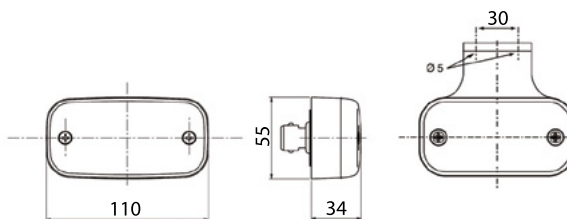

194130	PE	194150

094036

Feux de position - Position lamps - Positionsleuchten

FE02

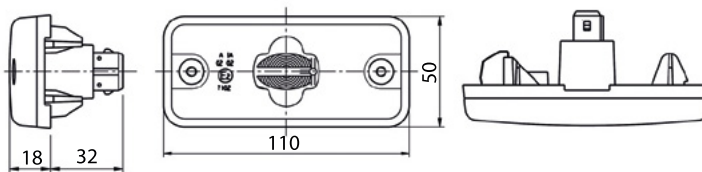

W5W



12/24V

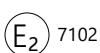

7102

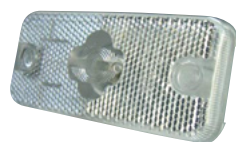

102200



clippé - clipped - clip-befestigung

D13876

JPT-2P-F

001726

FPL93

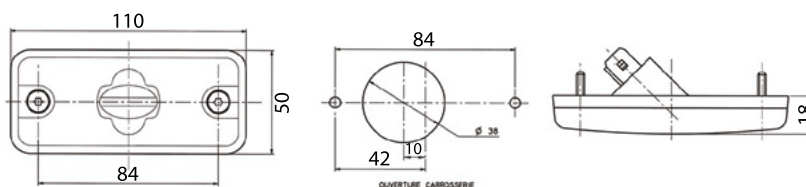

W5W



12/24V

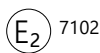

7102

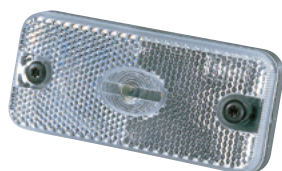

193200



vissé - screwed - geschraubt

D13876

JPT-2P-F

001726



p. 168

FE95



140 mm x 65 mm x 30,5 mm



W5W



12/24V

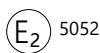

5052



195010

semelle plate - flat gasket - flache Sockeldichtung



195030

semelle gâbée - curved gasket - gewölbte Sockeldichtung

Affectations constructeurs
OE applications
Fahrzeugverwendung

DAF p. 20
RENAULT TRUCKS p. 63
VOLVO TRUCKS p. 101



FE87



 C5W

 12/24V

 E₂ 86710

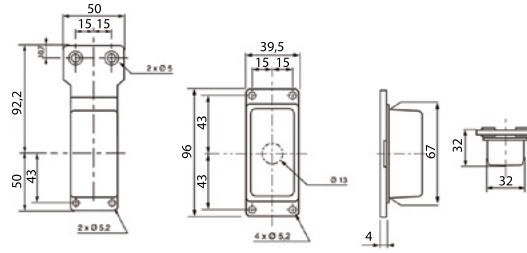

187120



187720



087020

cabochon - lens - Lichtscheibe

Feux de position - Position lamps - Positionsleuchten

FG80



R5W



12/24V



781
91715

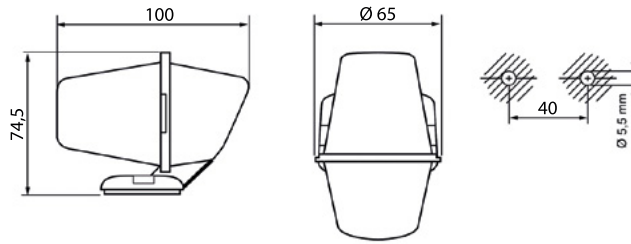

180010



080026



180040

R5W



080046

Feux de position - Position lamps - Positionsleuchten

SMD04



LED

24V

ADR



E₂ 05021

p. 160

p. 170

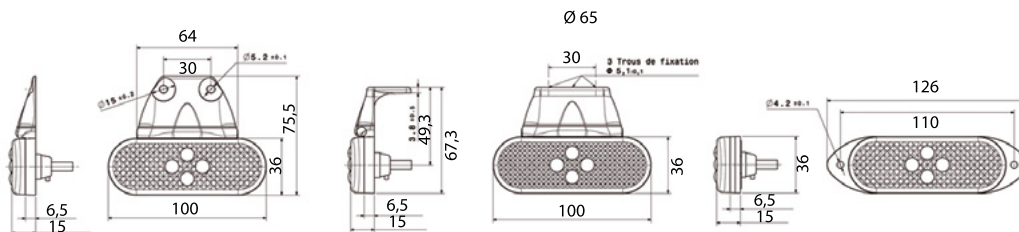

104090	500 mm	K	104210	500 mm	K	104250	500 mm	K
104100	1500 mm	K	104220	1500 mm	K	104260	1500 mm	K



104640	300 mm	K	D12699	1000 mm	K
104650	1000 mm	K			

bride rallongée - extended bracket - Montagewinkel verlängerter



NEW 104760	LED-12V	K	104770	LED-12V	K	NEW
104670	LED-24V	K	104700	LED-24V	K	



SMCU



FEUX DE POSITION LATÉRAUX LED CLIGNOTANTS gestion selon supplément 6 - R48
LED SIDE MARKER FLASHING LAMPS management supp 6 - R48
LED SEITLICHEN BLINKLEUCHTENT Ansteuerung gemäß der Erweiterung 6 - R48



12/24V **D14722**

LED Side marker control unit

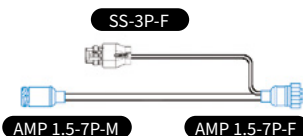

D14879



D14362

SS-3P-F



D13880

SS-2P-F

Feux de position - Position lamps - Positionsleuchten

SMD98

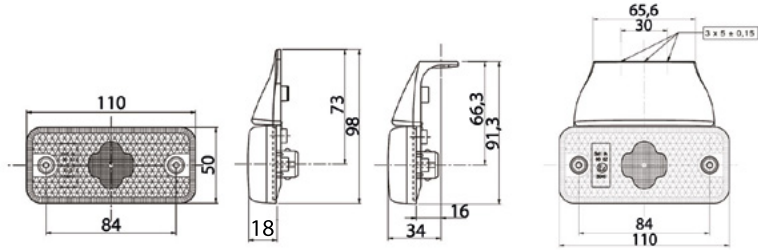

LED

12V
ou-or-oder
24V

ADR

4xLED

2xLED

E₂ 8040

p. 161

p. 166

Affectations constructeurs
OE applications
Fahrzeugverwendung

FELDBINDER p. 27
IVECO p. 34
LAMBERET p. 44
LECINENA p. 49
MERCEDES p. 55
RENAULT TRUCKS p. 63
VOLVO p. 101



198510 4 x LED-12V **K**



198520 4 x LED-24V **K**

JPT-2P-M



198810 4 x LED-12V **K**

198650 2 x LED-24V **K**

JPT-2P-M

198760 4 x LED-24V **K**

SS-2P-M



198580 4 x LED-12V **K**



198540 2 x LED-24V **K**

JPT-2P-M

198530 2 x LED-24V **K**

JPT-2P-M



D13713 1000 mm **K**

POS-2P-F

2 x LED-24V



D10493 500 mm **K**

4 x LED-24V



D10494 500 mm **K**

2 x LED-24V



D10495 500 mm **K**

2 x LED-24V

D10496 1500 mm **K**

CLICK-IN

D10497 1500 mm **K**

CLICK-IN

D10498 1500 mm **K**

CLICK-IN



D12867 2 x LED-24V **K**

CLICK-IN



D13876 JPT-2P-F



D13880 SS-2P-F



001696



001716

Feux de position - Position lamps - Positionsleuchten

SMD00



LED

24V

ADR



E₂ 1295

Affectations constructeurs
OE applications
Fahrzeugverwendung

RENAULT TRUCKS p. 63
VOLVO TRUCKS p. 101

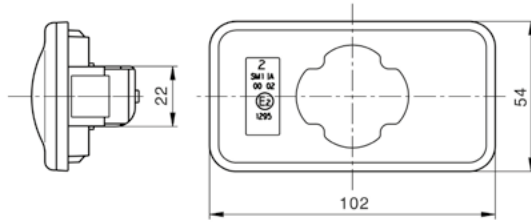

198620



Cuve blanche - cabochon PMMA
White body - PMMA lens
Weißes Gehäuse - PMMA Lichtscheibe



198740



Cuve ambre - cabochon PC résistant haute température et chocs
Amber body - high temperature and impact resistant PC lens
Oranges Gehäuse - Hochtemperatur- und schlagfestes PC Lichtscheibe



001766 600 mm

adaptateur - adaptor - Adapterkabel

FE94



T4W

12/24V

ADR



E₂ 4093

p. 161

p. 171

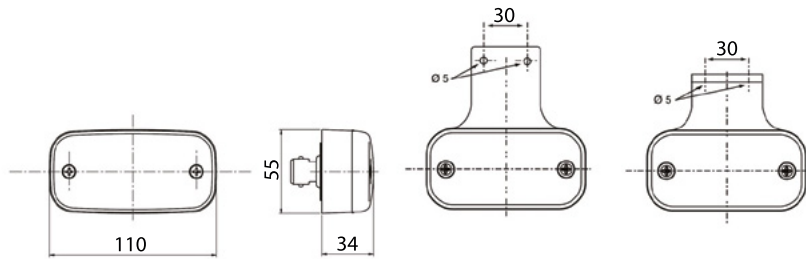

194010



PE



194020



194030



094016



Feux de position - Position lamps - Positionsleuchten

FPL93

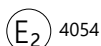
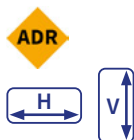
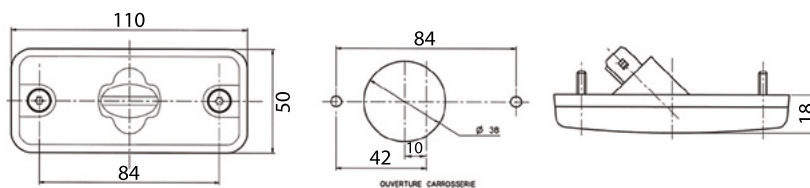

Affectations constructeurs
OE applications
Fahrzeugverwendung

DAF p. 20
FIAT p. 29
IVECO p. 34
RENAULT TRUCKS p. 63
VOLVO TRUCKS p. 101



193020



JPT-2P-M



193280



JPT-2P-M



193170



SS-2P-M



193360



SS-2P-M



193290

380 mm



SS-2P-M



D13876

JPT-2P-F



D13880

SS-2P-F



001726

JPT-2P-M



001916

SS-2P-M



001696



001716



FE87

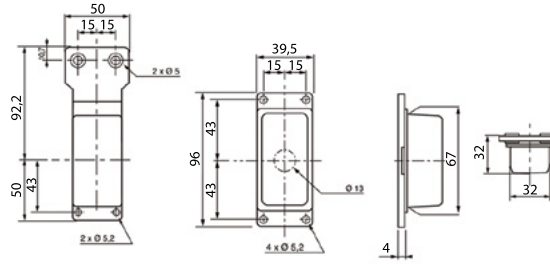
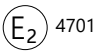

187140



187760



087040

cabochon - lens - Lichtscheibe

Feux de position - Position lamps - Positionsleuchten

FE04



LED

24V

ADR



E₂ 05011

p. 160

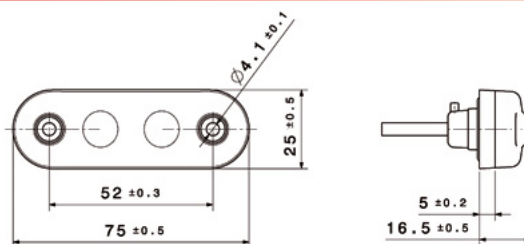

104330	500 mm
104340	1500 mm
104360	5000 mm



D10132 200 mm
CLICK-IN

SMD04



LED

24V

ADR



E₂ 05023

p. 160

p. 165

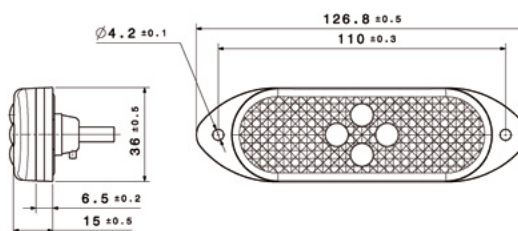

104170	500 mm	K		
104180	1500 mm	K	104680	K
			SS-2P-M	104710
			CLICK-IN	SS-2P-M



D13880 **SS-2P-F**

Feux de position - Position lamps - Positionsleuchten

SMD98



LED

24V

ADR

H

E₂ 2065

p. 161

p. 166

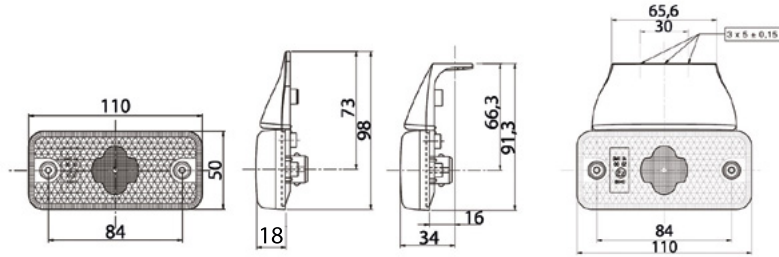

198640

K

JPT-2P-M

D11400 1500 mm

K

D10499 3500 mm

K

CLICK-IN



D13876

JPT-2P-F



001696



001716

FE94



T4W

12/24V

ADR

H V

E₂ 4091

p. 161

p. 167

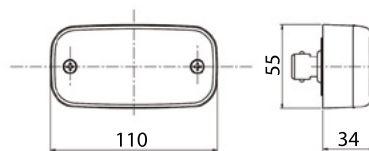

194250

K



PE



094056

K

Feux de position - Position lamps - Positionsleuchten

W97

83,8 mm x 24,2 mm x 10,4 mm



E₂₀ 1398
1397
1390
10R 2819

NEW



D16069
(66L708)

NEW



D16070
(66L709)

NEW



D16071
(66L710)

NEW



D16072
(66L710B)

NEW



D16073
(66L710G)

FE87



E₂ 86711

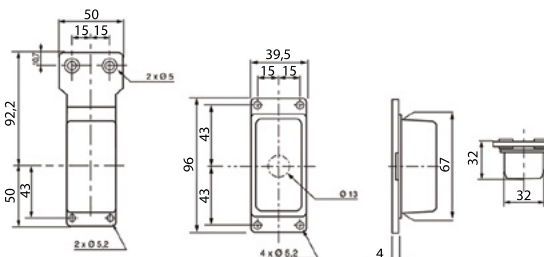

187130



187730



087030

cabochon - lens - Lichtscheibe

FE95



140 mm x 65 mm x 30,5 mm



E₂ 5126



195060

Feux de gabarits

End outline marker lamps

Begrenzungsleuchten



Tricolore - Tricolour - Dreifarbig

p. 174-176



Bicolore - Bicolor - Zweifarbig

p. 177-178



SS-2P-F

Type connecteur - Nb pins - Mâle ou Femelle
Connector type - Pins Nb - Male or Female
Steckertyp - Stifte Nb - männlich oder weiblich



Flashez le QR code pour plus d'infos
Scan the QR code for more info
Scannen Sie den QR-Code für weitere Informationen



Pièces détachées
Spare parts
Ersatzteile



Numéro d'homologation
Approval number
Zulassungsnummer

Feux de gabarits - End outline marker lamps - Begrenzungsleuchten

FA3 LED



LED

12/24V

ADR

E₂ 14010

* fils nus - naked cable extre-
mity - Kabellitze

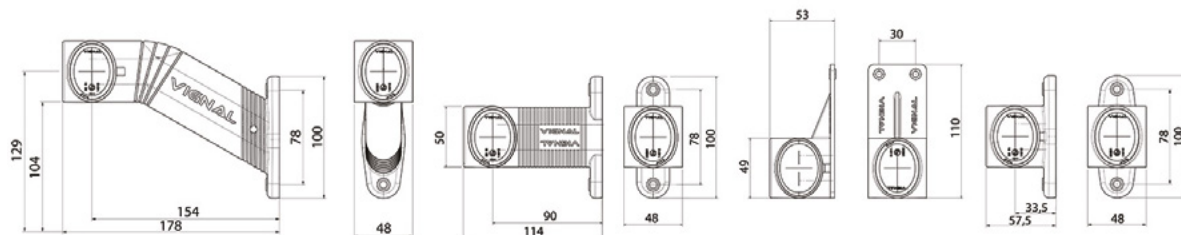

D14421* 1700 mm

D14427 1500 mm

gauche - left - links



D14422* 1700 mm

D14428 1500 mm

droit - right - rechts



D14423 1500 mm

gauche - left - links



Pour / For / Für LC8
D14423 - D14424 - D13875

CLICK-IN



D14424 1500 mm

droit - right - rechts

CLICK-IN



D14425 1500 mm

gauche - left - links



Pour / For / Für LC12T
D14425 - D14426 - D14655

SS-2P-F



D14426 1500 mm

droit - right - rechts

SS-2P-F



D14431* 1700 mm

D14429 1500 mm

gauche - left - links

CLICK-IN



D14432* 1700 mm

D14430 1500 mm

droit - right - rechts

CLICK-IN



D14031* 1700 mm

D14035 1500 mm

D14655 1500 mm

symétrique - symmetrical - symmetrisch

CLICK-IN

SS-2P-F



D14030* 1700 mm

D14034 1500 mm

D13875 1500 mm

symétrique - symmetrical - symmetrisch

CLICK-IN

SS-2P-F

FA3 LC12 LED



LED

12/24V

ADR

E₂ 14010



D14781 350 mm
gauche - left - links **SS-2P-F**



D14782 350 mm
droit - right - rechts **SS-2P-F**

FA3 LED LC8



LED

12/24V

ADR

E₂ 14010



D14038 500 mm
gauche - left - links **CLICK-IN**



D14037 500 mm
droit - right - rechts **CLICK-IN**



D14039 350 mm
gauche - left - links **POS-2P-F**



D14040 350 mm
droit - right - rechts **POS-2P-F**

Feux de gabarits - End outline marker lamps - Begrenzungsleuchten

DX LC8



W5W



24V

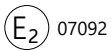

07092



D13034 500 mm
gauche - left - links **CLICK-IN**



D13035 500 mm
droit - right - rechts **CLICK-IN**



D12712 350 mm
gauche - left - links **POS-2P-F**



D12711 350 mm
droit - right - rechts **POS-2P-F**

DX



W5W



24V

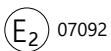

07092



D12430



D12429 1500 mm
CLICK-IN



D12428 1400 mm
CLICK-IN

DX LED



90 mm x 50 mm x 180 mm



12/24V

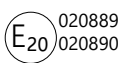

020889
020890



D13624
fils nus - naked cable extremity - Kabellitze

Feux de gabarits - End outline marker lamps - Begrenzungsleuchten

DX



W5W

12/24V

ADR

E₂ 10035

* fils nus - naked cable extremity - Kabellitze

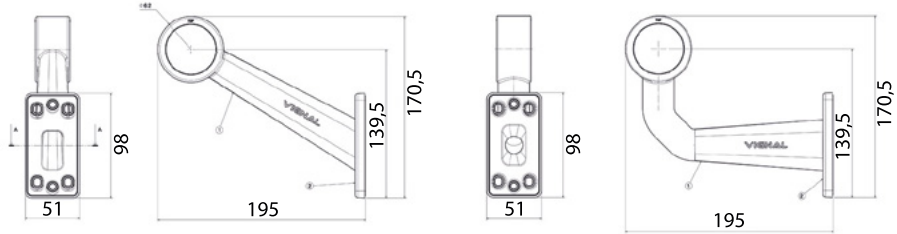

D10642 *



D10643 *



D10503

600 mm

CLICK-IN



D10800

R5W - 12/24V



D11899

500 mm

2 voies - 2 poles - 2 polig
Pour / For / Für LC8



POS-2P-F



611010



611020



D13277 350 mm



D11147 500 mm



610080 R5W

Lampe non fournie - bulb
not included - nichte inklusiv
glühlampen

FE12



LED

12/24V

E₂₄ 020078

* fils nus - naked cable extremity - Kabellitze

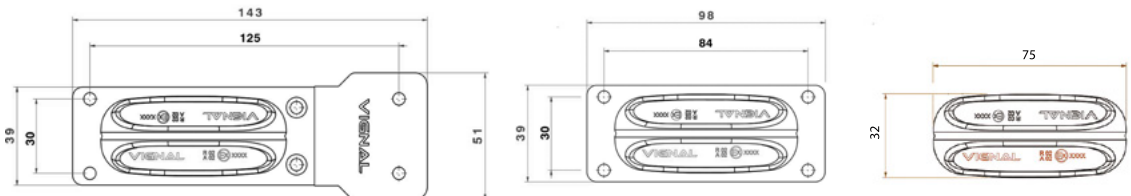

112110 * 1000 mm



112710 * 1000 mm



112120 * 1000 mm

112130 1500 mm **CLICK-IN**

112720 1500 mm **CLICK-IN**

Feux de gabarits - End outline marker lamps - Begrenzungsleuchten

FE88

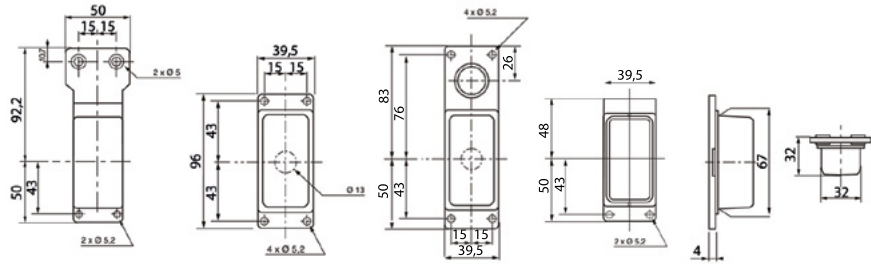
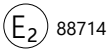

188110



188210



188010

pour presse-étoupe 000176
for o-ring 000176
für PG-Verschraubung 000176



188710



188610

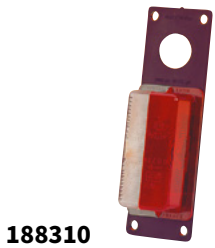

188310



088010

cabochon - lens - Lichtscheibe



000176

FE81



107 mm x 47 mm x 41 mm



181000



000086

Signalisation passive

Warning products

Warnmarkierungen



Bandes réfléchissantes - Reflective tapes - Reflektierende Streifen

p. 180-181



Plaques réfléchissantes - Reflective plates - Rückstrahlende Tafeln

p. 182-183

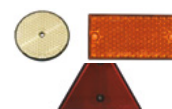

Catadioptres - Reflectors - Rückstrahler

p. 184

Triangle de présignalisation - Warning triangle - Warndreiecke

p. 184



Flashez le QR code pour plus d'infos
Scan the QR code for more info
Scannen Sie den QR-Code für weitere Informationen



Pièces détachées
Spare parts
Ersatzteile



Numéro d'homologation
Approval number
Zulassungsnummer

Bandes réfléchissantes - Reflective tapes - Reflektierende Streifen

R104



50 m x 50,8 mm

Surface rigide - Rigid support - Auf Festaufbauten

E₁₃ 104R-0001



D12713



D12715



D12714

E₁₃ 104R-0002



D13206



D13205



D13207

Surface souple - Curtain support - Für Plane

Carrés pré-espacés - segmented squares - vorgeschrittene Quadrate

50 m x 50,8 mm

NEW

Surface rigide - Rigid support - Auf Festaufbauten

E₁ 104R



D16087



D16086



D16088

NEW

E₁ 104R-003244

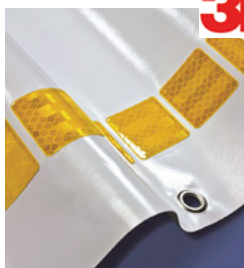

D16104



D16103



D16105

Surface souple - Curtain support - Für Plane

Carrés pré-espacés - segmented squares - vorgeschrittene Quadrate

Bandes réfléchissantes - Reflective tapes - Reflektierende Streifen

BA



2 x 9 m x 141 mm



D14714 Cl. A: >80m

D14716 Cl. B: >500m

Classe 1 : ville et route nationale - town and trunk roads - Stadt und Landstrassen
 Classe 2 : autoroutes et voies rapides - highways - Autobahnen und Schnellstrassen

2 x 45 m x 141 mm



D14715 Cl. A: >80m

REFLECTIVE KIT



Homologué - Durable - Visible minimum à 80m - Facile à poser
 Approved - Durable - Visible at least 80m - Easy to install
 Zugelassen - Langlebig - Sichtbar aus mindestens 80m Entfernung - Einfach zu verlegen

Ref sur demande
 P/N on request - Artikelnummer auf Anfrage

NEW

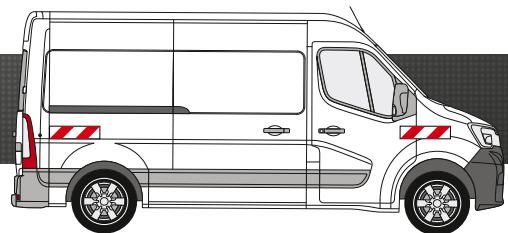
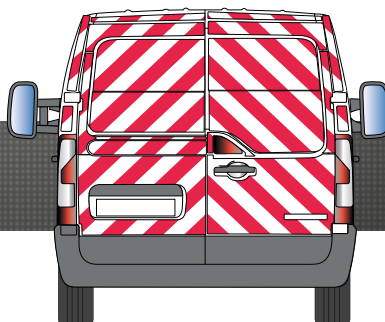
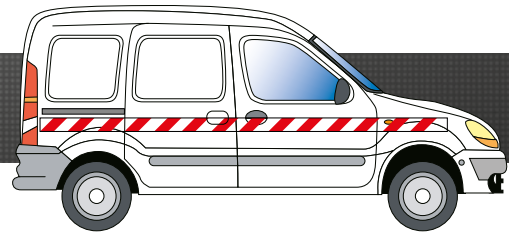
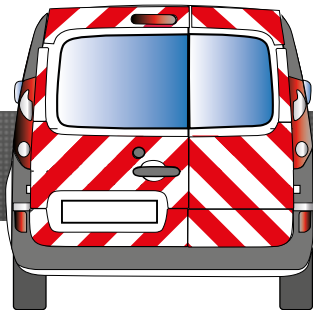

Plaques réfléchissantes - Reflective plates - Rückstrahlende Tafeln

R70



Camions / Cars et bus - Trucks / Coaches - LKW / Busse

1 x (130 x 1130)

2 x (130 x 565)

4 x (130 x 282)

E₄ 017016



* adhésif - adhesive - Selbstklebend

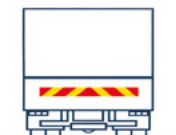

D14710 Alu 1 mm

D14706 Adhésif *

D14711 Alu 1 mm

D14707 Alu 1 mm

D14535 Plastique

Remorques - Trailers - Anhänger

1 x (195 x 1130)

2 x (195 x 565)

4 x (195 x 283)



D14712 Alu 1 mm

D14708 Adhésif *

D14713 Alu 1 mm

D14709 Alu 1 mm

D14536 Plastique

DSR



250 mm x 170 mm

250 mm x 170 mm



D14990

Camions et poids lourds

D14991

Cars et bus

Plaques réfléchissantes - Reflective plates - Rückstrahlende Tafeln

CONVOI



423 x 423 x 1 mm

NEW



D16031

(76RE50) Cl. A: 👁️ ->80m

Classe 1 : ville et route nationale - town and trunk roads - Stadt und Landstrassen
Classe 2 : autoroutes et voies rapides - highways - Autobahnen und Schnellstrassen

282 x 282 x 1 mm

NEW



D16032

(76RE56) Cl. B: 👁️ ->250m

1200 x 400 mm

NEW



D16026

(80CONVOIEX03) Cl. B: 👁️ ->250m



1900 x 250 mm

NEW

CONVOI EXCEPTIONNEL

D16027

(80CONVOIEX04) Cl. B: 👁️ 250m

PICTOGRAM



E₂ 10R-03

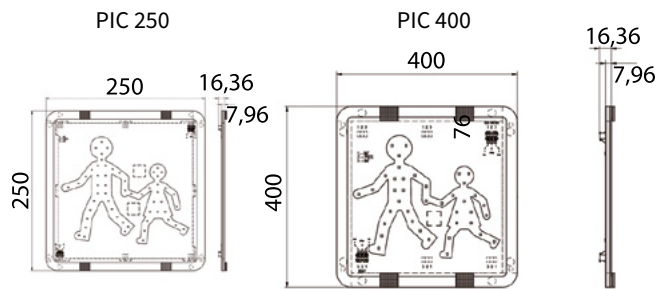

NEW



1x PIC 250 + 1x PIC 400 + cache/cover



D16008

(PIC250/400.C.SC/C)

NEW



1x PIC 250 + 1x PIC 400



D16009

(PIC250/400.C.ES.SC/C)

Catadioptrés - Reflectors - Rückstrahler

CA



Ø 61 mm

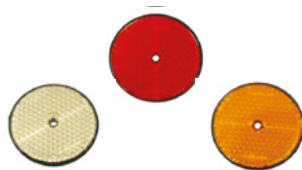

D14592



D14591



D14593



adhésif - adhesive - Selbstklebend

Ø 85 mm

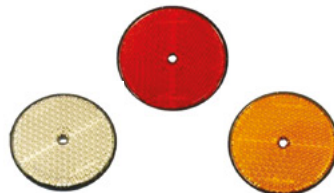

D14589



D14588



D14590



adhésif - adhesive - Selbstklebend

57 mm x 39 mm



D14595



D14594



D14596



adhésif - adhesive - Selbstklebend

105 mm x 45 mm

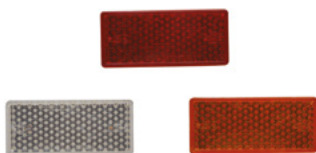

240366



240346



240356



adhésif - adhesive - Selbstklebend

105 mm x 45 mm - M4

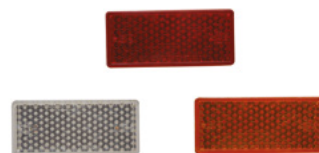

241366



241346



241356



adhésif - adhesive - Selbstklebend

105 mm x 54 mm



D14530



D14529



D14531



adhésif - adhesive - Selbstklebend

159 mm x 159 mm x 159 mm



D14587

TRIANGLE



Affectations constructeurs
OE applications
Fahrzeugverwendung

RENAULT TRUCKS p. 63
SCANIA p. 91
VOLVO p. 101



D10596

(564.VTO.VLG)

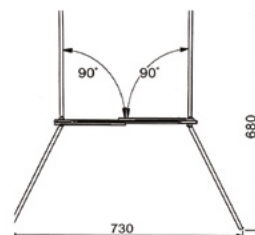
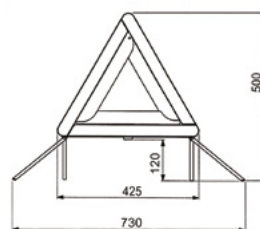

Phares de travail Work lights Arbeitscheinwerfer



Phares de recul - Reverse work lights - Rückfahrlicht Arbeitscheinwerfer

p. 186



LED

p. 187-200



DT-2P-M

Type connecteur - Nb pins - Mâle ou Femelle
Connector type - Pins Nb - Male or Female
Steckertyp - Stifte Nb - männlich oder weiblich



Vitre en verre trempé
Tempered glass lens
Lichtscheibe aus gehärtetem Glas



Flashez le QR code pour plus d'infos
Scan the QR code for more info
Scannen Sie den QR-Code für weitere Informationen



Vitre en polycarbonate
Polycarbonate lens
Lichtscheibe aus Polycarbonat



Pièces détachées
Spare parts
Ersatzteile



Faisceau p. 262
Harness p. 262
Anschlusskabel siehe S. p. 262

SL 1000 R23



DT-2P-M

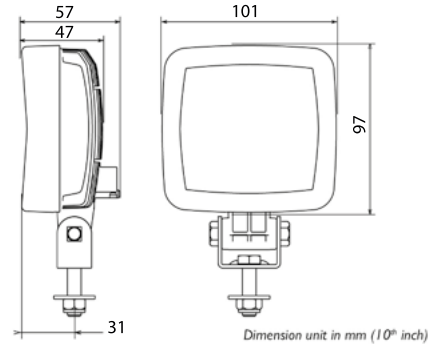

LED

12/24V
14W

1000 Lumen

ADR

D14857
(A0787A711300)

✓ R23 ✓ R10

E₂ 19140

IP69K



DT-2P-M

D14880
(A0787A712400)

Aluminium



2963 R23

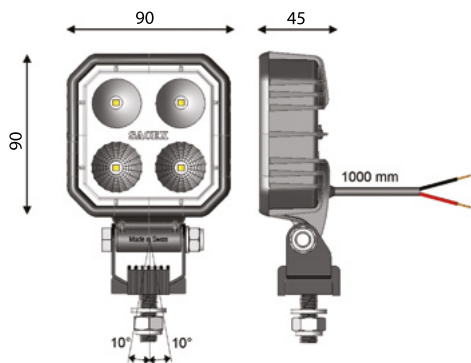

LED

10/30V
9W

1000 Lumen

✓ R23 ✓ R10

E₁₁ 7573

IP69K

D14555
(29.63.L23.C0V) 1000 mm

D14556 *
(29.63.L2I.CDV)



* Interrupteur - switch - Schalter

SV 1000



NEW

LED

12/24V
20W

1000 Lumen

IP69K

* Interrupteur - switch -
Schalter

Nouveau! Meilleure solution 1000 Lumen en remplacement un phare halogène
Phare de travail professionnel, boîtier plastique robuste et fiabilité des performances.
New! Best 1000 Lumen solution to replace a halogen work light
Professional lamp, robust plastic casing and reliable performance.
Neu! Beste Lösung 1000 Lumen als Ersatz für einen Halogenscheinwerfer.
Professioneller Arbeitsscheinwerfer mit robustem Kunststoffgehäuse und zuverlässiger Leistung.

NEW

PC



DT-2P-M



D16111
(A0767A769600)

D16155
(A0767A769700)

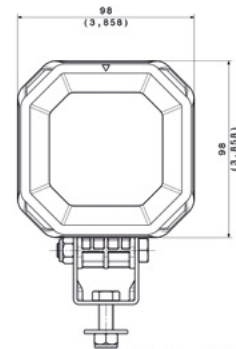
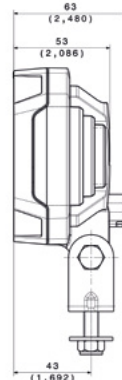

Dimension unit in mm (In)

NEW

PC



FIL-CABLE

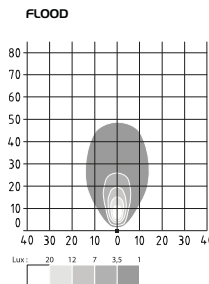

D16156
(A0767A769800)

D16157
(A0767A769900)



Phares de travail - Work lights - Arbeitsscheinwerfer

 **OE Original Parts**

Eclairage flood homogène de proximité

*Homogeneous flood lighting
Homogene Flood-Beleuchtung im Nahbereich*

1000, 1500 ou 2000 Lumen effectifs

*1000, 1500 ou 2000 Effective Lumen
1000, 1500 oder 2000 Effektive Lumen*

Rond, Carré, Rectangle ou Ovale

*Round, Square, Rectangle or Oval
Rund, quadratisch, rechteckig oder oval*

Compatibilité Électro-Magnétique classe 5

*Electro-Magnetic Compatibility class 5
Elektromagnetische Kompatibilität Klasse 5*

Protection Load dump

*Load dump protected
Load Dump geschützt*



SL 1000



LED

 12/24V
14W

 1000 Lumen

 **IP69K**

PC



D14850
(A0787A710700)



DT-2P-M

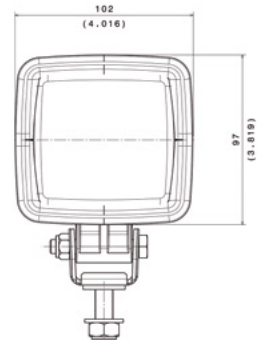
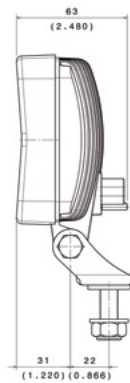
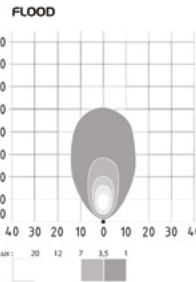

SL 1500



LED

 12/24V
20W

 1500 Lumen

 **IP69K**

PC



D14851
(A0787A710800)



DT-2P-M

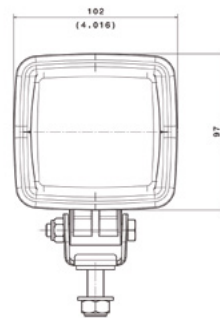
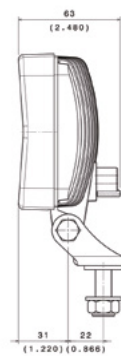
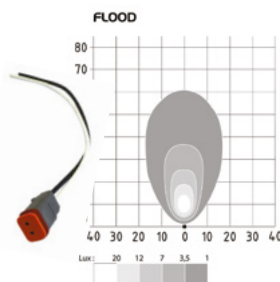

SLA 2000



LED

12/24V
29W

2000 Lumen

IP69K



DT-2P-M



D14852
(A0787A710900)

Aluminium [SCANIA p. 92](#)

NEW



LEAR-2P-M

D16110
(A0787A7548C3)

Aluminium [MAN p. 53](#)

PC



DT-2P-M



D14856
(A0787A711700)

Aluminium

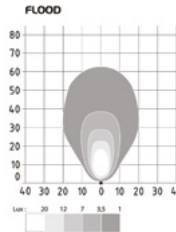
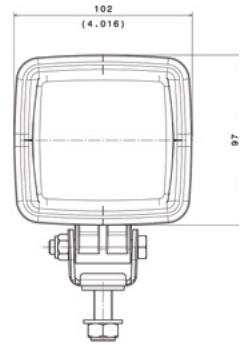
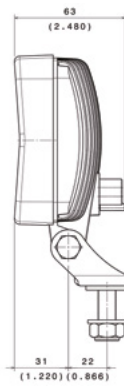

RLA 2000



LED

12/24V
29W

2000 Lumen

IP69K



DT-2P-M

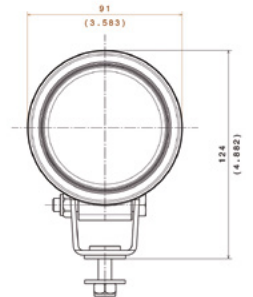
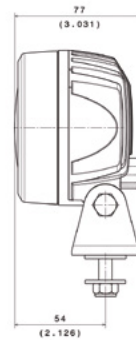
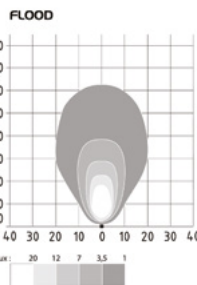

D14855
(A0187A711200)

Aluminium

NO GLARE



N'éblouit ou n'aveugle pas - Éclaire la zone de travail
 No blinding or dazzling - Illuminates work area
 Kein Blenden - Beleuchtet den Arbeitsbereich

LED

12/24V
 29W

2000 Lumen

IP69K



DT-2P-M



D14968
 (A0787A7284C3)

Aluminium

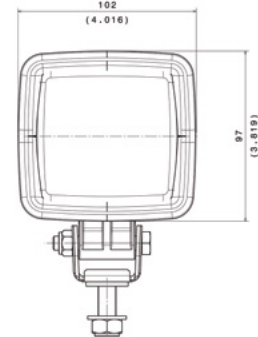
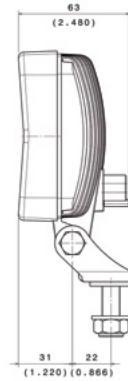

NEW



DT-2P-M



D15077
 (A0187A7603C3)

Aluminium

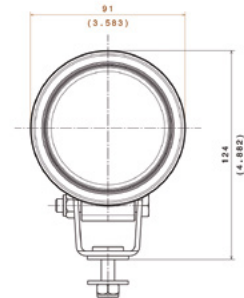
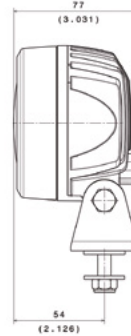

QLA 1000



NEW



DT-2P-M

LED

12/24V
14W

1000 Lumen

IP69K



D16119
(A0427A755400)

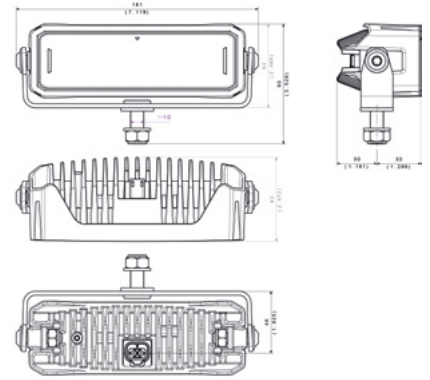
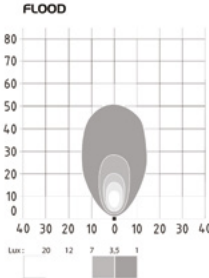

QLA 2000



NEW



DT-2P-M

LED

12/24V
29W

2000 Lumen

IP69K



D16120
(A0427A755600)

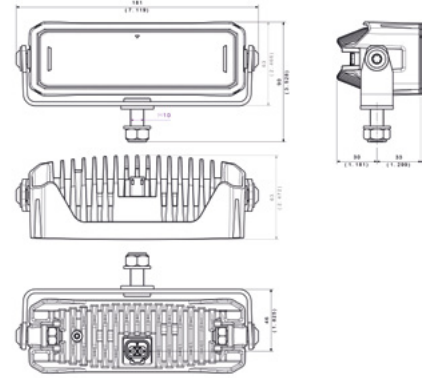
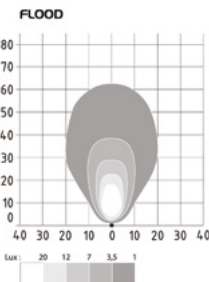

QLA GLOWING



NEW



DT-2P-M

LED

12/24V
29W

IP69K



D16114
(A0427A773600)

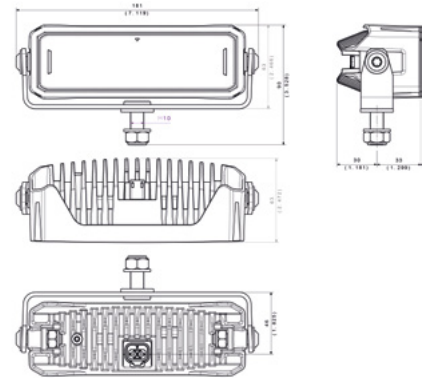
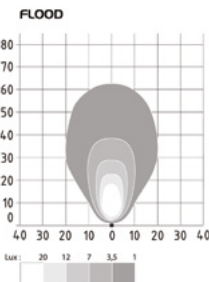

OLA 1000



DT-2P-M

LED

12/24V
14W

1000 Lumen

IP69K

D14965
(A0487A7402C3)

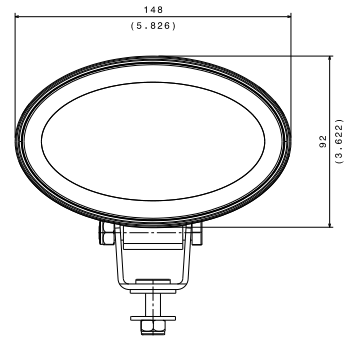
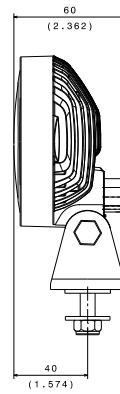
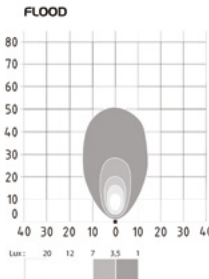

NEW



DT-2P-M

D15093
(A0487A7479C3)

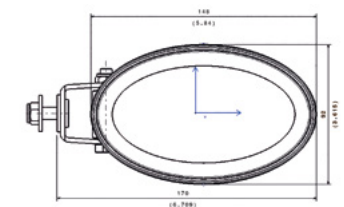
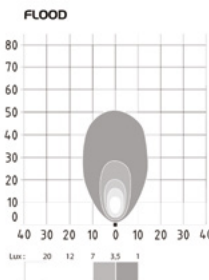

OLA 1500



DT-2P-M

LED

12/24V
20W

1500 Lumen

IP69K

D14966
(A0487A7406C3)

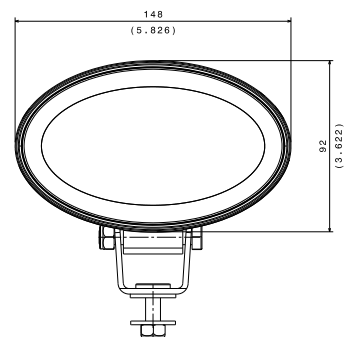
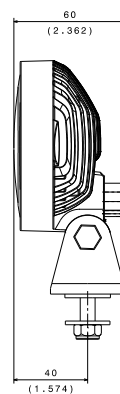
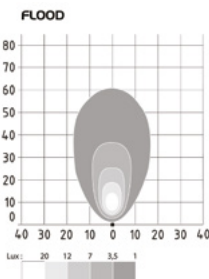

OLA 1500



NEW



LED

12/24V
14W

1000 Lumen

IP69K

D15094
(A0487A7481C3)

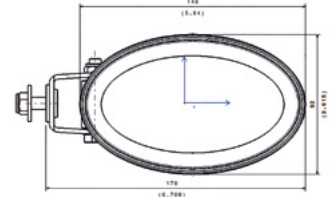
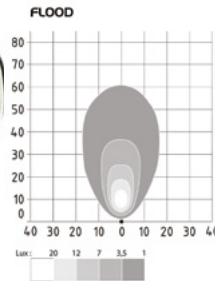

OLA 2000



LED

12/24V
29W

2000 Lumen

IP69K

D14967
(A0487A7499C3)

Aluminium

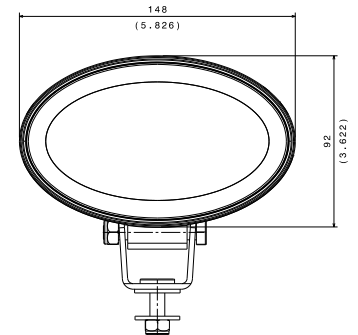
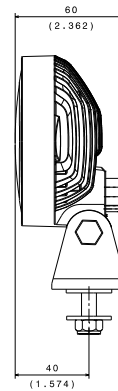
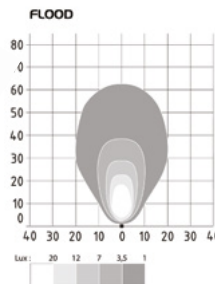

NEW



D15095
(A0487A7483C3)

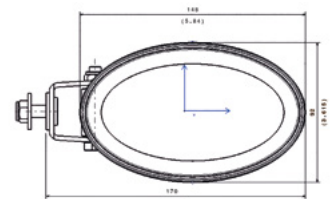
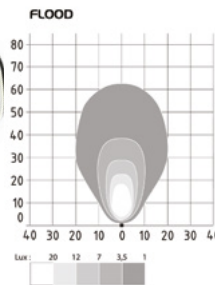

SHD 3000



NEW



LED

12/24V
36 W

3000 Lumen

IP69K



DT-2P-M

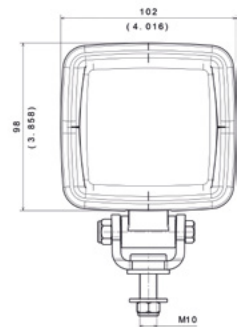
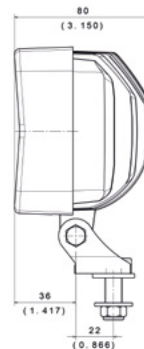
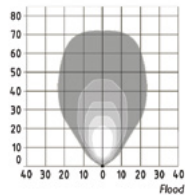

D15100
(A0787A7739C3)
Aluminium

SHD 5000



NEW



LED

12/24-100V
57 W

5000 Lumen

IP69K



DT-2P-M

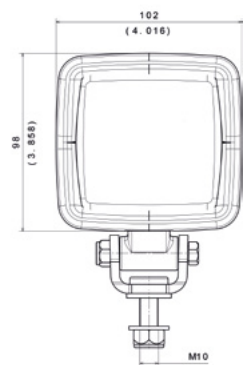
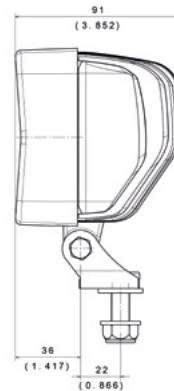
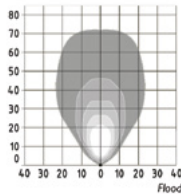

D16124
(A0787A7737C3)
Aluminium

BL15



LED

24V



E2 16007
10R-0516079

Affectations constructeurs
OE applications
Fahrzeugverwendung

CHEREAU p. 17
FRUEHAUF p. 31
LECAPITAINE p. 48
TROUILLET p. 97

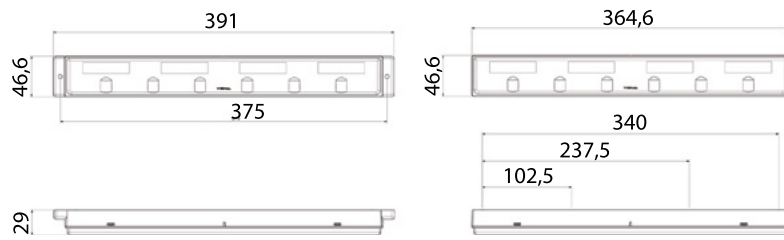

165020
gauche - left - links



DTM04-4P-M



DTM06-4S-4P-F

Fixation par l'arrière
Back fixation
Rückenfixierung



165030
droit - right - rechts



165040
gauche - left - links

Fixation par l'avant
Front fixation
Frontfixierung



165050
droit - right - rechts



D14436 DTM06-4S-4P-F



D14435 DTM04-4P-M

Indicateur de direction à défilement - feux de détresse flash
Dynamic indicator lights - warning lights
Dynamischer Blinker - blinkende Warnleuchte

Feu de travail 1200 Lumen
Work light 1200 Lumen
Arbeitsscheinwerfer 1200 Lumen

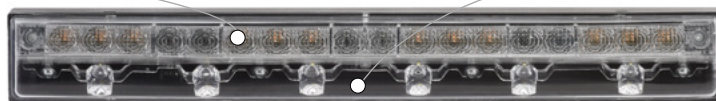

2960



LED



10/30V
12 W



1500 Lumen



IP69K



D14540
(29.60.L00.C0V) 1000 mm

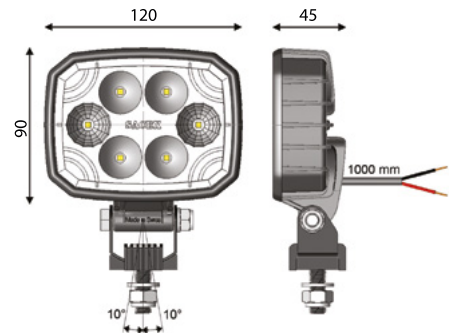

2961



LED



10/30V
12 W



1500 Lumen



IP69K



D14542
(29.61.L00.C0V) 1000 mm

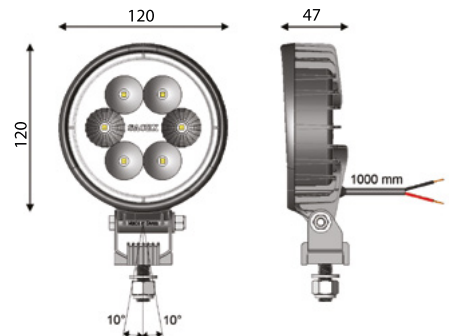

2962



LED



10/30V
12 W



1500 Lumen



IP69K



D14544
(29.62.L00.C0V) 1000 mm

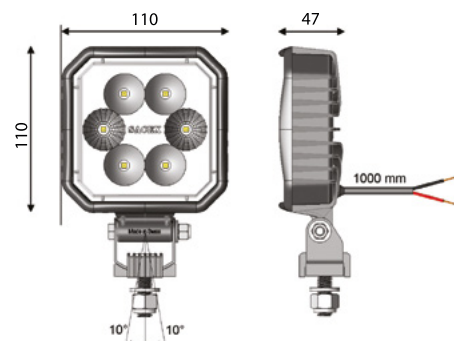

2963



LED

10/30V
9 W

1000 Lumen

R10

IP69K



D14547
(29.63.L00.C0V) 1000 mm



D14552
(29.63.LA0.C0V) 1000 mm

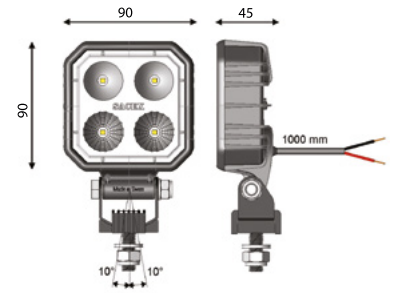

D14553
(29.63.L0A.C0V) 1000 mm

2963



LED

10/30V
9 W

1000 Lumen

R10

IP69K



D14549 *
(29.63.LMI.C0V) 1000 mm

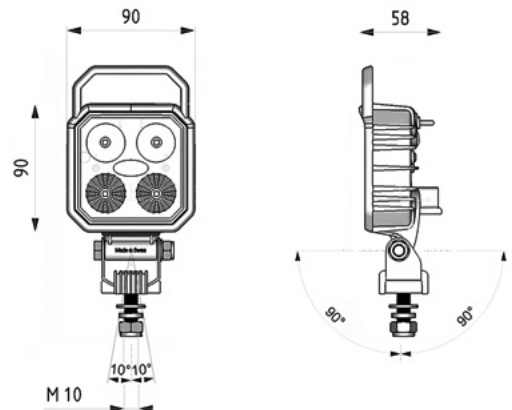
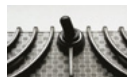

*Interrupteur - switch - Schalter

RC 850 LED



PC

LED

10/30V
12 W

1500 Lumen

R10

IP69K



D14743 1000 mm

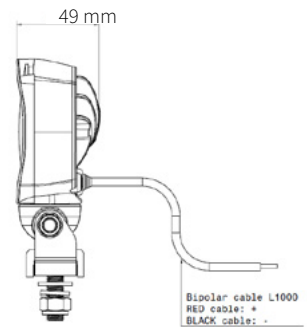
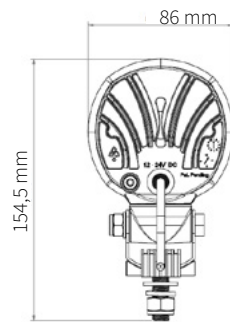

PC



D14744



DT-2P-M

PC



D14745
clippé - clipped - clip-befestigung

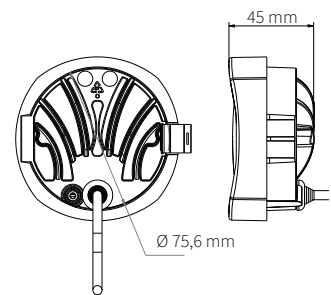
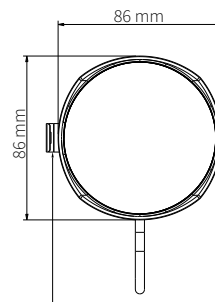

Compact (Ø 8,6 cm) et léger
Compact (Ø 8,6 cm) and light
Kompakt (Ø 8,6 cm) und leicht



FTC



LED

12/24V
15 W

850 Lumen



IP69



D14191

batterie rechargeable
rechargeable battery
Akku



High power 100%
Eco 30%
Flash SOS

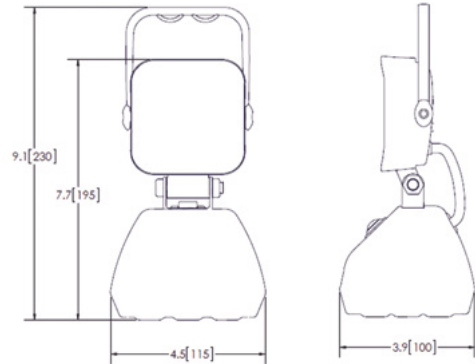

MINILIGHT



LED

12/24V

1000 Lumen

R10



IP67

NEW



D14994

(MINILIGHT.CR) 1000 mm

111 mm x 84 mm



NEW



D15048

(MINILIGHT.CRI) 1000 mm

Interrupteur - switch - Schalter



CAMLIGHT

LED

NEW



12/24V



1000 Lumen

Caméra
Camera
Kamera



R10



IP69K

D16042
(69 CAMLIGHT1)

DT-2P-M



2 en 1 : éclaire tout en filmant - réduit les angles morts - connexion moniteur via sortie vidéo 4 pins
2 in 1: illuminates while filming - reduces blind spots - monitor connection via 4-pin video output
2 in 1: beleuchtet während des Filmens - reduziert tote Winkel - Monitoranschluss über 4-poligen Videoausgang



Éclairage de sécurité Warning lights Sicherheitsbeleuchtungen



DT-2P-M

Type connecteur - Nb pins - Mâle ou Femelle
Connector type - Pins Nb - Male or Female
Steckertyp - Stifte Nb - männlich oder weiblich



Vitre en verre trempé
Tempered glass lens
Lichtseibe aus gehärtetem Glas



Flashez le QR code pour plus d'infos
Scan the QR code for more info
Scannen Sie den QR-Code für weitere Informationen

Éclairage de sécurité - Warning lights - Sicherheitsbeleuchtungen

SL BLUE



NEW



LED

12/36V
15W



IP69K



D16118
(A0787A763800)



DT-2P-M

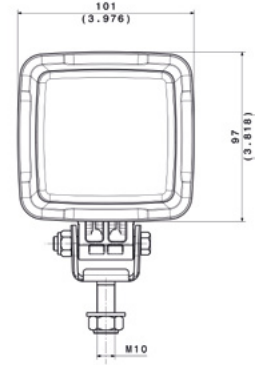
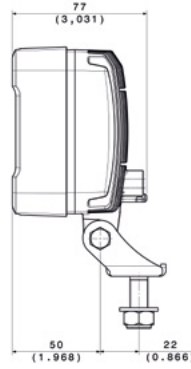

SHD BLUE RED



LED

12/24-100V
5W



IP69K



D14249
(A0787A625500)



DT-2P-M

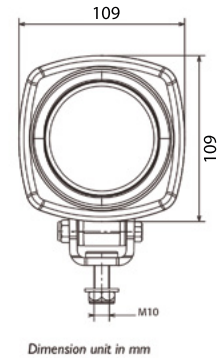
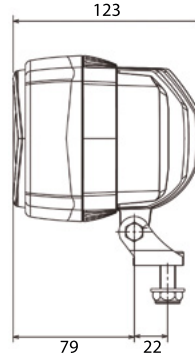

Dimension unit in mm



WARNING LINE



COMPACT - KOMPAKT



LED

12/24-80v
6W



IP67



D14357



D14358

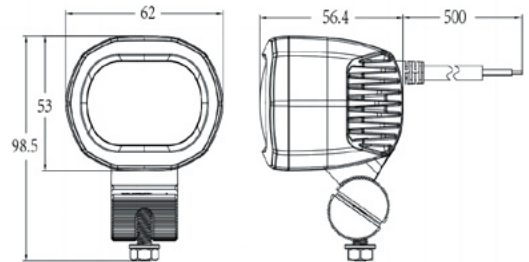

SAFETY STATIC



NEW

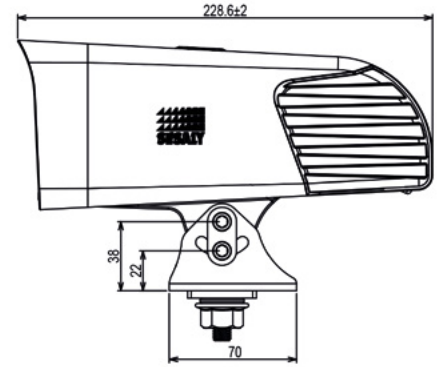
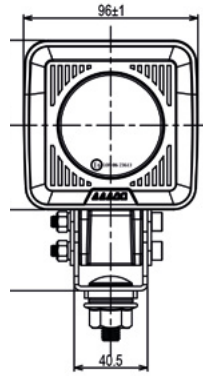

LED

10/30V
28W

E₉ 10R-06 23613

D16160

IP69K



SESA MOONLIGHT



NEW



LED

12/24V
15 W

IP69K

D16022
(MOO.SIV.W)

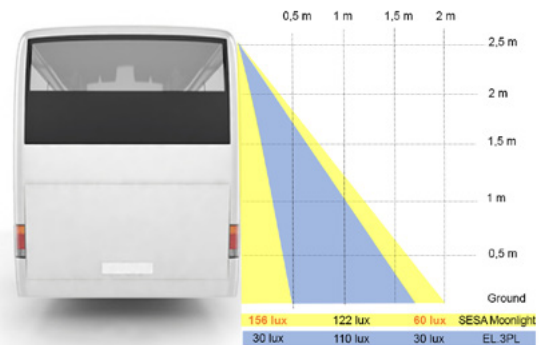

NEW



D16023
(MOO.SIV.R)

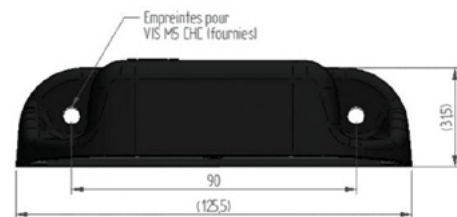
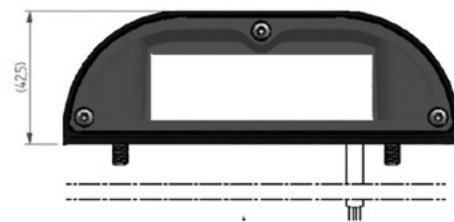

Phares de conduite

Headlights

Fahrlichter



DT-2P-M

Type connecteur - Nb pins - Mâle ou Femelle
Connector type - Pins Nb - Male or Female
Steckertyp - Stifte Nb - männlich oder weiblich



Flashez le QR code pour plus d'infos
Scan the QR code for more info
Scannen Sie den QR-Code für weitere Informationen



Pièces détachées
Spare parts
Ersatzteile

CHL 2 LED



LED

10/36V
50W High Beam
30W Low Beam



E R112 - R6 - R7



IP69K

ISO PULSE
13207-1



Phare de conduite LED homologué

LED homologated combination headlight
LED-homologierter Fahrlichter

Performance lumineuse best in class

Brightest & most innovative plow light
Lichtleistung best in class

Compatibilité plug and play

Plug and play compatibility
Plug-and-Play-Kompatibilität

Design évite l'accumulation de neige et de glace

Flush lens design to prevent snow and ice buildup
Design verhindert Schnee- und Eisansammlungen

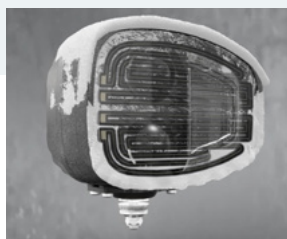

Nouveau! Technologie de dégivrage active et autonome
New! Active and autonomous de-icing technology
Neu! Aktive und autonome Enteisungstechnologie

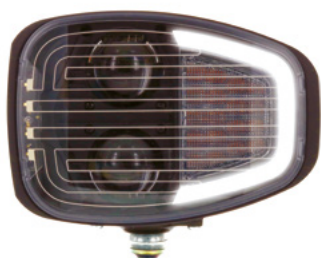

D14964
(A0831A7332A4)

gauche - left - links



DT04-6P-M

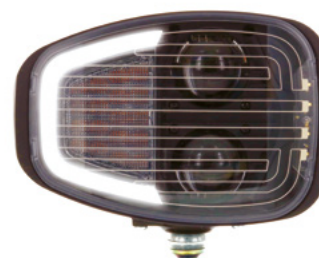

D14963
(A0831A7333A4)

droit - right - rechts

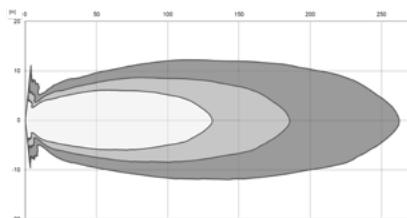

High beam light pattern

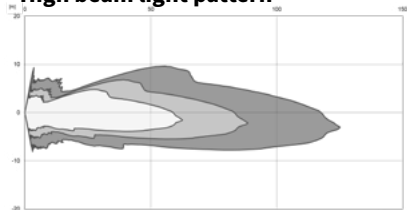

Low beam light pattern

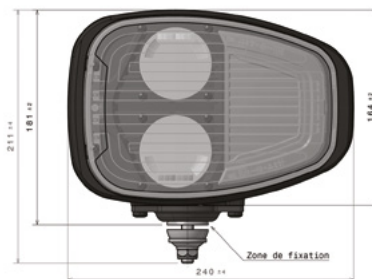
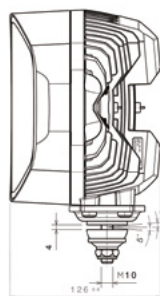

D14352
(A87005182400)

DT04-6P-F

CHL 1 LED



LED

12/24V
50W High Beam
48W Low Beam

ECE

E R112 - R6 - R7

IP69

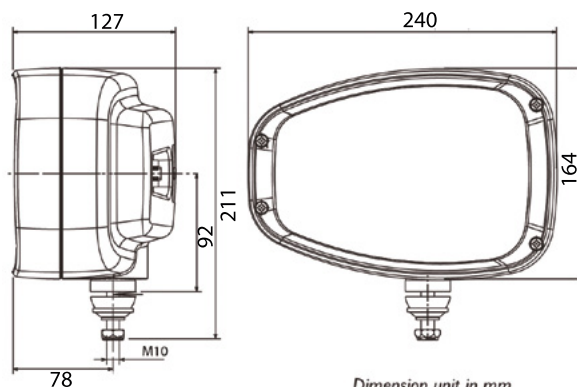

Feux de route - Feux de croisement - Indicateur de direction avant et latéral - Position
High beam - Low beam - Front and side direction indicator - Position
Fernlicht - Abblendlicht - Vorne und seite blinker - Position



D14324
(A0831A673200)

gauche - left - links



DT04-6P-M



D14325
(A0831A673300)

droit - right - rechts



D14352
(A87005182400)

DT04-6P-F

SAE



Ref sur demande
P/N on request - Artikelnummer auf Anfrage

CHL1 H4

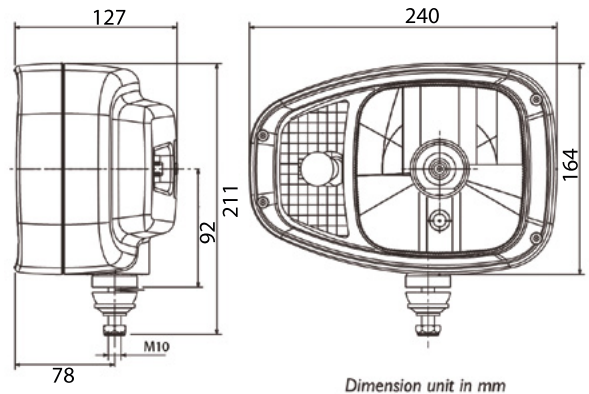
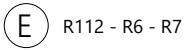

D14320
(A0830A673600) 12V

D14322
(A0830A673400) 24V

gauche - left - links



DT04-6P-M



D14321
(A0830A673700) 12V

D14323
(A0830A673500) 24V

droit - right - rechts



D14352
(A87005182400)

DT04-6P-F

CL2 LED

LED

12/24V



5W Low Beam OFF Road

3W Turn light

2W Pilot light



IP69



R148 - R149

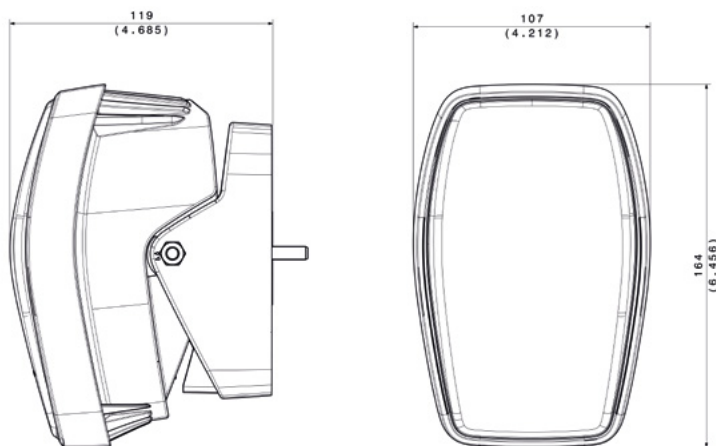

Dimension unit in mm (Inch)



Feux de croisement - Indicateur de direction - Position

Low beam - Direction indicator - Position

Abblendlicht - Blinker - Position



NEW



D16115
(A0801A765600)

gauche - left - links



FEP-4P-M

NEW



D16115
(A0801A765600)

droit - right - rechts

Feux auxiliaires

Auxiliary lights

Zusatzscheinwerfer



Flashez le QR code pour plus d'infos
Scan the QR code for more info
Scannen Sie den QR-Code für weitere Informationen

LED BARS SIGNAL



NEW

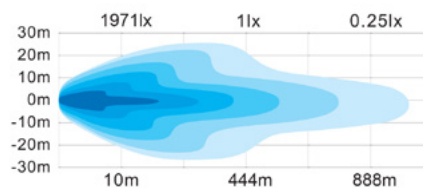
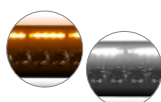

LED

12/24V

IP69K

R112

D16047 21,5"

Phare longue portée R112 - Flash ambre R65 - Position ambre et blanc
R112 long-range light - Amber flash R65 - Amber and white position
R112 Fernlicht - gelbes Blitzlicht R65 - gelbe und weiße Position

NEW

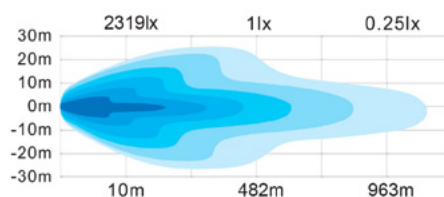

D16048 21,5"

Phare longue portée R112 - dégivrage automatique
R112 long-range light - automatic de-icing
R112 Fernlicht - Automatische Enteisung



NEW

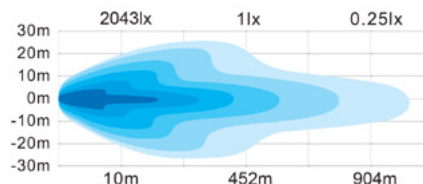

D16049 20"

Phare longue portée R112
R112 long-range light
R112 Fernlicht

NEW

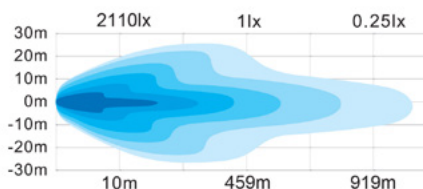

D16050 20"

Phare longue portée R112- flash ambre R65
R112 long-range light - amber flash R65
R112 Fernlicht - Gelbes Blitzlicht R65

LED BARS SIGNAL



NEW

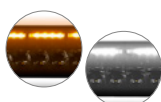

LED



12/24V



IP69K



R112



D16051 13"

Phare longue portée R112 - Flash ambre R65 - Position ambre et blanc
R112 long-range light - Amber flash R65 - Amber and white position
R112 Fernlicht - gelbes Blitzlicht R65 - gelbe und weiße Position

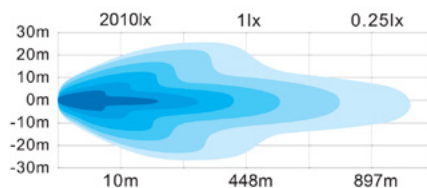

NEW



D16052 13"

Phare longue portée R112
R112 long-range light
R112 Fernlicht

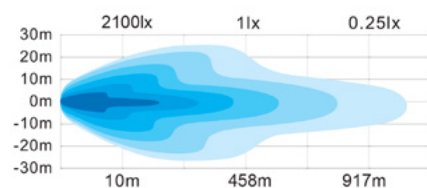

NEW



D16053 10"

Phare longue portée R112
R112 long-range light
R112 Fernlicht

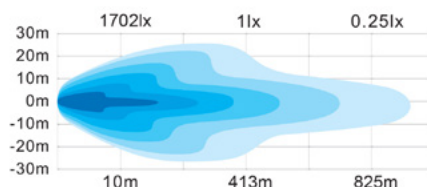

LED BARS ECO



NEW

LED



10/30V



IP67



D16040 425 mm



D16041 630 mm

ALPHA 230 PRO LED

LED

NEW

12/24V
50W

3450 Lumen

IP68



D16122
(A2894A769300)

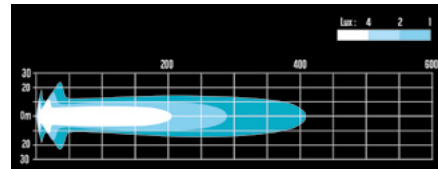
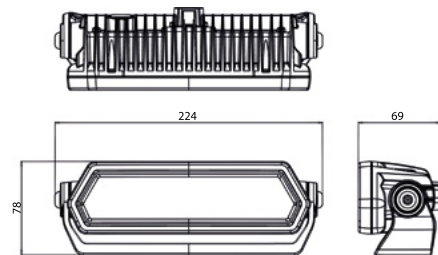

ALPHA 630 PRO LED

LED

NEW

12/24V
260W

15100 Lumen

IP68



D16123
(A2894A769400)

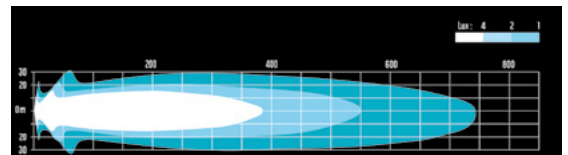
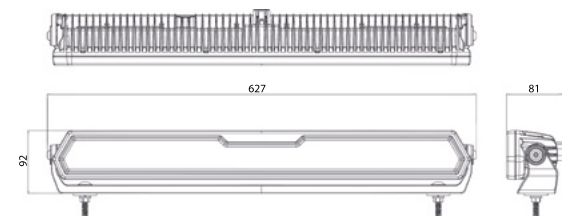

ALPHA 225 XENON



35W-D1S GEN5
24V
43 W

E4 16903

* lampe fournie - bulb included - inklusiv glühlampen

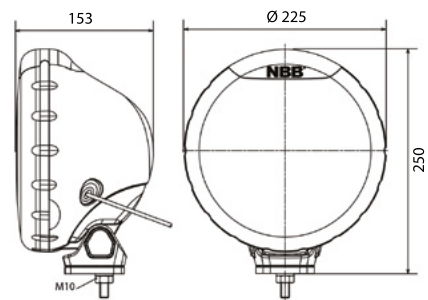

Dimension unit in mm

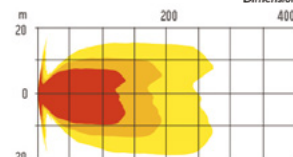

ALPHA 225



H1-12/24V
70W Max

E4 16902

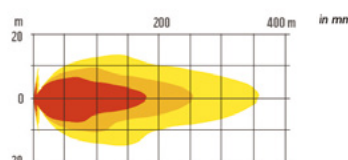
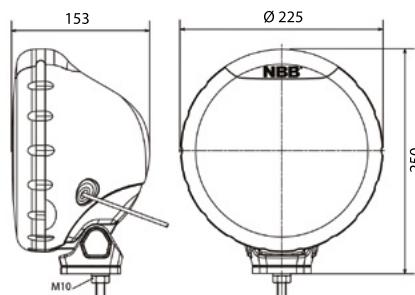

D14166
(A0330A657400)

AUXILIARY



NEW

LED

12/24V
108W

IP69K

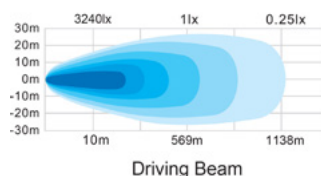
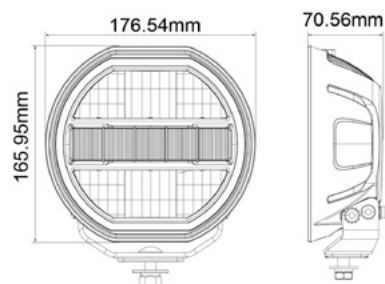

D16077 7"

Phare longue portée R149 - Position ambre et blanc
R149 long-range light - Amber and white position
R149 Fernlicht - gelbe und weiße Position

SEARCHLIGHT



NEW

360°

LED

10/30V

IP67



D16067

Pilotage télécommande
Remote control
Fernbedienung ansteuern

360°



D16068

Pilotage télécommande ou smartphone
Remote control or smartphone app
Steuerung per Fernbedienung oder Smartphone-App

Éclairage intérieur

Interior lights

Innenraum-Beleuchtungen



DT-2P-M

Type connecteur - Nb pins - Mâle ou Femelle
Connector type - Pins Nb - Male or Female
Steckertyp - Stifte Nb - männlich oder weiblich



Flashez le QR code pour plus d'infos
Scan the QR code for more info
Scannen Sie den QR-Code für weitere Informationen



Pièces détachées
Spare parts
Ersatzteile

RCL 1200



LED

9-30V

1200 Lumen

R10

IP6K9K

filz nus - naked cable extre-
mity - Kabellitze

Affectations constructeurs
OE applications
Fahrzeugverwendung

LAMBERET p. 44

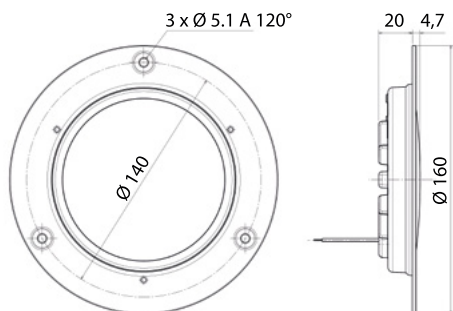

300010

6 LEDS



300000

6 LEDS

chromé - chrome-plated - verchromt

FE02



W5W - 12/24V

ADR



E₂ 7102

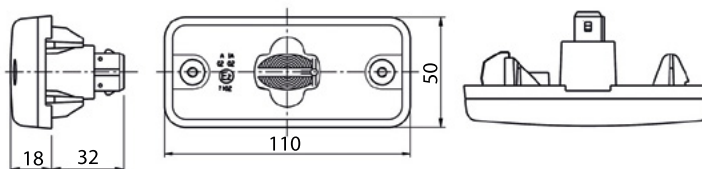

102200

K

clippé - clipped - clip-befestigung



D13876

JPT-2P-F



001726

2250



LED

10-30V

R10

IP69

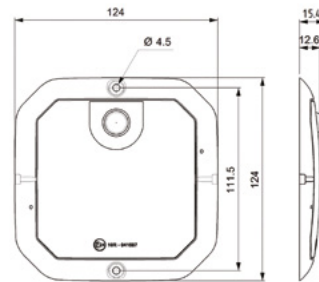
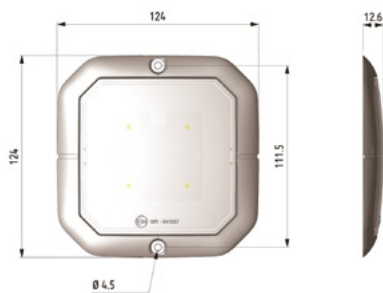

> 4 m <
timer 5 min

500 Lumen

D14569
(22.50.LP4.VLG) 4 LEDS - PIR

Avec détecteur de mouvement et chaleur (capteur PIR) - with motion and heat detector (PIR sensor) - Mit Bewegungs- und Wärmemelder (PIR sensor)



> 4 m <
timer 5 min

500 Lumen

MASTER
D14598
(22.50.LP4.MSV) 4 LEDS - PIR

Avec détecteur de mouvement et chaleur (capteur PIR) - with motion and heat detector (PIR sensor) - Mit Bewegungs- und Wärmemelder (PIR sensor)



500 Lumen

D14567
(22.50.L04.VLG) 4 LEDS

Sans détecteur de mouvement et chaleur (capteur PIR) - without motion and heat detector (PIR sensor) - ohne Bewegungs- und Wärmemelder (PIR sensor)



750 Lumen

D14568
(22.50.L06.VLG) 6 LEDS

Sans détecteur de mouvement et chaleur (capteur PIR) - without motion and heat detector (PIR sensor) - ohne Bewegungs- und Wärmemelder (PIR sensor)

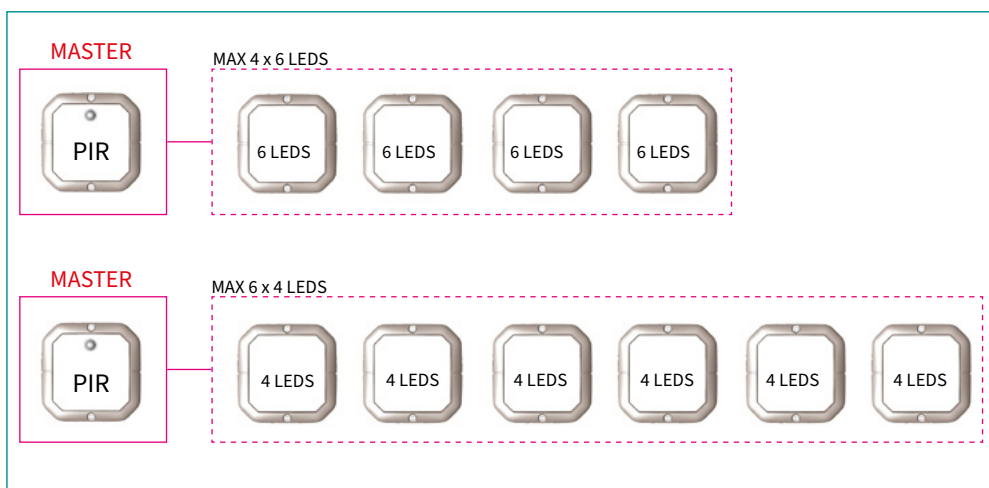

Exemple de montage Maître (PIR) + Esclaves - Assembly suggestion
Master (PIR) + Slaves - Montagebeispiel Meister (PIR) + Sklave

SESA ZENITH



LED

12/24V

R10

IP67

filis nus - naked cable extremity - Kabellitze

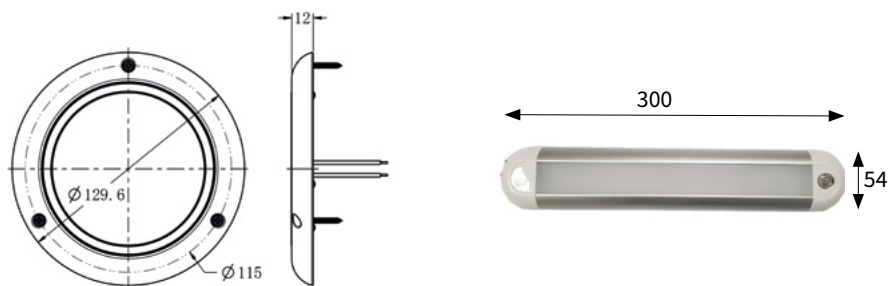

NEW



D16010

NEW



D16093

Bouton tactile - Touch button - Berührbare Taste

LED STRIP



LED

24V

IP68

NEW

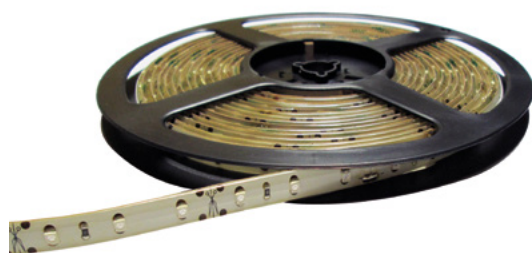

D16030

5 m



Gyrophares

Beacons

Rundumkennleuchten

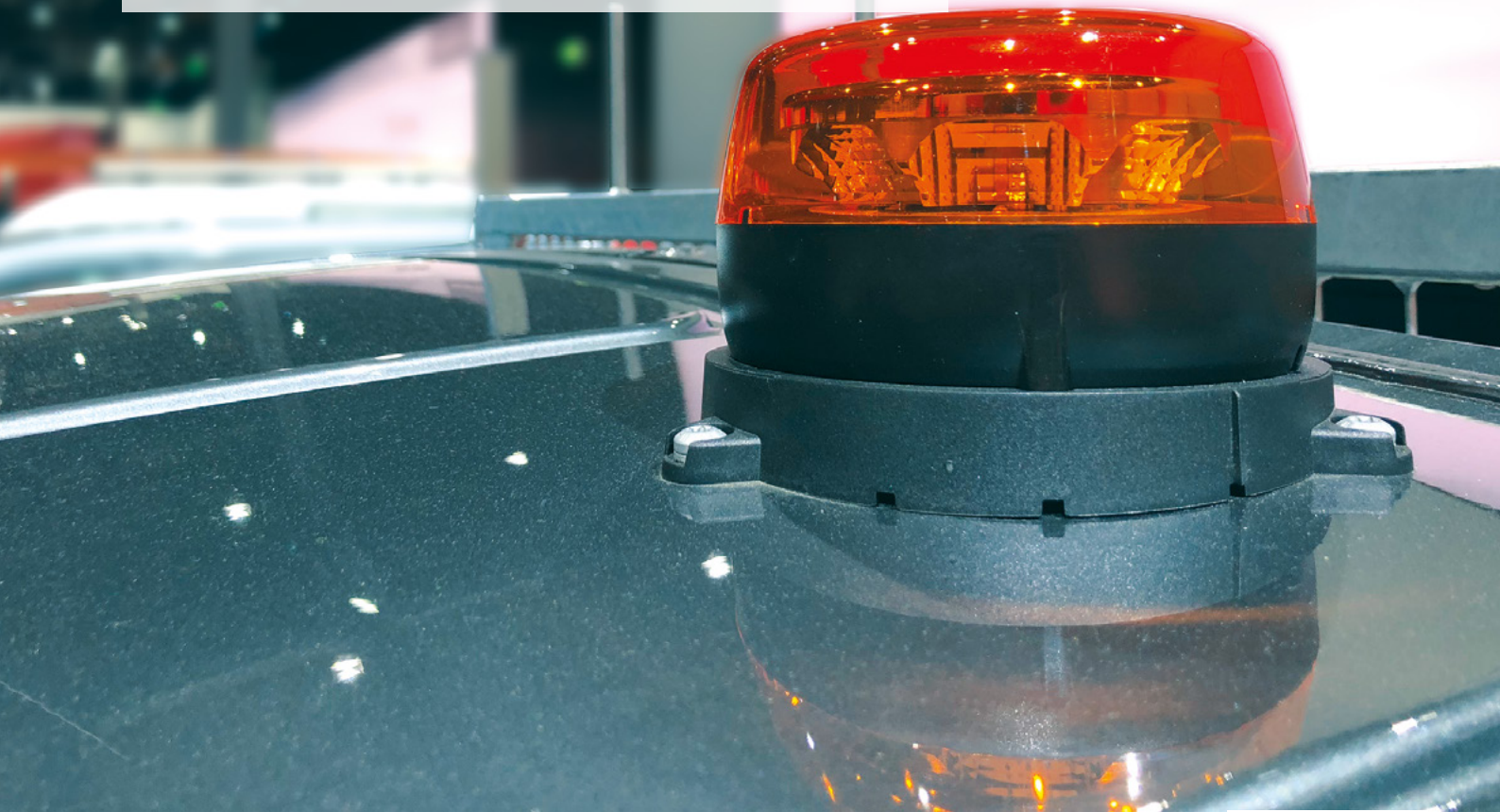

LED

p. 219-228



Halogène

p. 229



 Montage sur tige
DIN pole mounting
Für Aufteckrohr

 Fixation à visser
Screw mounting
Schraubbefestigung

 Magnétique
Magnetic
Magnetfuß

 LED Rotatif
LED Rotative
Rotierend LED

 LED à éclats
LED Flash
Blitze LED

 Polycarbonate
Polycarbonate
Polycarbonat



Flashez le QR code pour plus d'infos
Scan the QR code for more info
Scannen Sie den QR-Code für weitere Informationen



Indice de protection IP - solides/liquides
IP ingress protection - solids/liquids
IP Schutzfaktor - Fremdkörper/Wasser



Pièces détachées
Spare parts
Ersatzteile



Homologation circulation réseau routier public
Approval circulation on public road network
Genehmigung des öffentlichen Straßennetzes



Homologation CEM - compatibilité électromagnétique
EMC approval - Electromagnetic Compatibility
EMV zulassung - Elektromagnetische Verträglichkeit



Accessoires p. 230
Accessories p. 230
Zubehör S. p. 230

ATLASSINO

LED

10/30V
10 W - 16 W

R65 R10

SAE

IP6K9K

PC



Le gyrophare R65 le plus compact

The most compact R65 beacon
Die kompakteste Blitz-Kennleuchte R65

Double flash extra lumineux

Extra-bright double flash
Extra heller Doppelblitz

LED puissante longue durée

Powerful, long-life LED
Langlebige, leistungsstarke LED

Heavy duty - excellente résistance aux vibrations

Heavy duty - excellent vibration resistance
Heavy duty - ausgezeichnete Vibrationsresistent



ATLAS

ATLASSINO

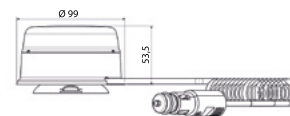
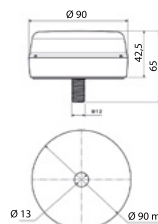
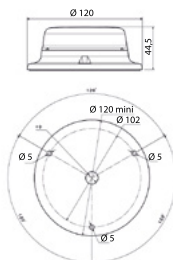
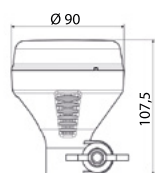

NEW



221300

CEM Class 5



NEW



221100 cable central

221200 cable lateral

filis nus - naked cable extremity - Kabellitze
CEM Class 5



NEW



221000

filis nus - naked cable extremity - Kabellitze
CEM Class 5



NEW



221500

CEM Class 5



Autres couleurs sur demande
Other colors on request
Weitere Farben auf Anfrage

Gyrophares - Beacons - Rundumkennleuchten

ATLAS



LED

10/30V
11 W - 17 W

✓ R65 ✓ R10

✓ SAE



IP6K9K



Affectations constructeurs
OE applications
Fahrzeugverwendung

DE BUF p. 25

MAN p. 52

MERCEDES p. 55

RENAULT TRUCKS p. 63

VOLVO p. 101

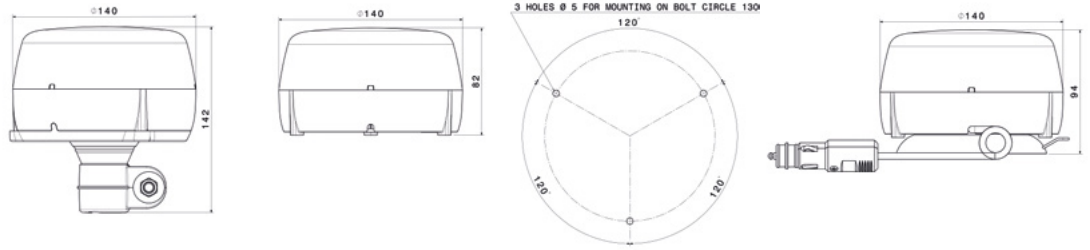

NEW



212420



212400



211000



CEM Class 5

CEM Class 3

CEM Class 5
MONOBLOC



212120



212020



212730



fils nus - naked cable extremity - Kabellitze
CEM Class 5

CEM Class 5
MAN p. 52

POS-2P-M

CEM Class 5
VOLVO p. 104

TYCO MCON-2P-M



212710



212010



212740



CEM Class 5
MERCEDÉS p. 55

CEM Class 4
MERCEDÉS p. 56

KOSTAL-2P-M

CEM Class 5
RENAULT TRUCKS p. 63

AMP-4P-F



212520



212560



CEM Class 5



Durée de vie optimale - Gestion thermique des Leds - CEM
Classe 3-5
Optimum service life - LED thermal management - EMC
Class 3-5
Optimale Lebensdauer - LED-Thermomanagement - EMV-
Klasse 3-5

ATLAS



LED

10/30V
11 W - 17 W

✓ R65 ✓ R10

IP69



Affectations constructeurs
OE applications
Fahrzeugverwendung

RENAULT TRUCKS p. 63
VOLVO p. 101

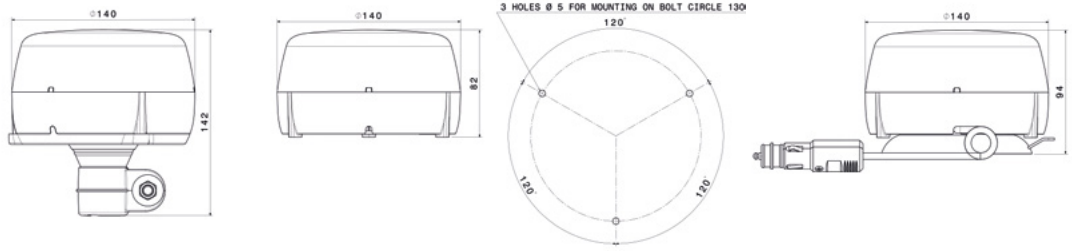

212470



CEM Class 5



212030



CEM Class 5
MAN p. 52

POS-2P-M



212170



filis nus - naked cable extremity - Kabellitze
CEM Class 5



212570



CEM Class 5



212750*



CEM Class 5
RENAULT TRUCKS p. 63

AMP-4P-F

Gyrophares - Beacons - Rundumkennleuchten

PEGASUS



LED

10/30V
9 W

✓ R65 ✓ R10



* Multifunction - Multifunktions
** Rotative - Rundumlauf

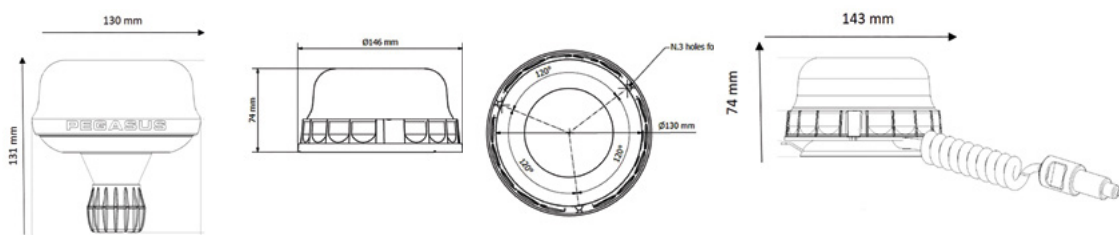

3 Types de flash homologués ECE R65
3 Flash patterns certified ECE R65
3 Blitzarten ECE R65 zugelassen

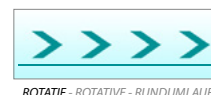

FLEXI

D14501
(21.50.L75.5V8) Multifonction*

D14725
(21.50.L75.3V8) Rotatif**



D14500
(21.50.L35.5V8) Multifonction*

D14724
(21.50.L35.3V8) Rotatif**



D14502
(21.50.LV5.5V8) Multifonction*

D14726
(21.50.LV5.3V8) Rotatif**



D14503
(21.50.811.MUV) Multifonction*

cabochon - lens - Lichtscheibe



FLEXI

D14757
(21.50.L75.51V) Multifonction*



D14756
(21.50.L35.51V) Multifonction*



D14758
(21.50.LV5.51V) Multifonction*



D14747
(21.50.201.MUV) Multifonction*

cabochon - lens - Lichtscheibe

GALAXY LED



LED

10/30V
9 W

✓ R65 ✓ R10

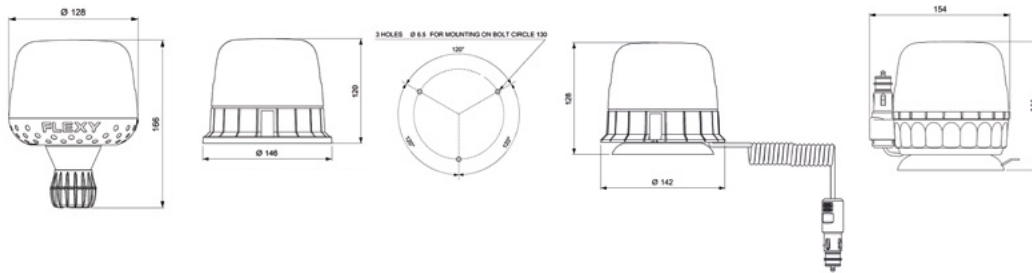

FLEXI

D14488
(21.49.L75.3V8)



D14487
(21.49.L35.3V8)



D14489
(21.49.LV5.3V8)



D14493
(21.49.L75.1V8)



D14492
(21.49.L35.1V8)



D14494
(21.49.LV5.1V8)



D14490
(21.49.LR5.3V8)



D14495
(21.49.LR5.1V8)



D14755
(21.49.LR5.11V)



ROLL CABLE

ROLL CABLE



FLEXI

D14753
(21.49.L75.11V)



D14752
(21.49.L35.11V)



D14754
(21.49.LV5.11V)



D14491
(2149.815.RTV)



D14779
(21.49.801.VLG)



D14496
(2149.815.LMV)



cabochon - lens - Lichtscheibe

cabochon - lens - Lichtscheibe

Gyrophares - Beacons - Rundumkennleuchten

E-VENUS LED

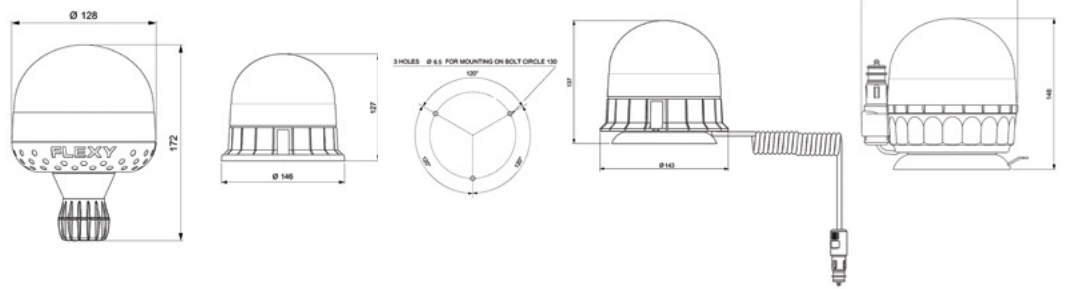

LED

10/30V
9 W

R65 R10



made w/solar elec

NEW



FLEXI

D16151



NEW



D16150



NEW



D16152



NEW



D16153



D16161

cabochon - lens - Lichtscheibe

VEGA LED



LED

10/30V
9 W

R65 R10

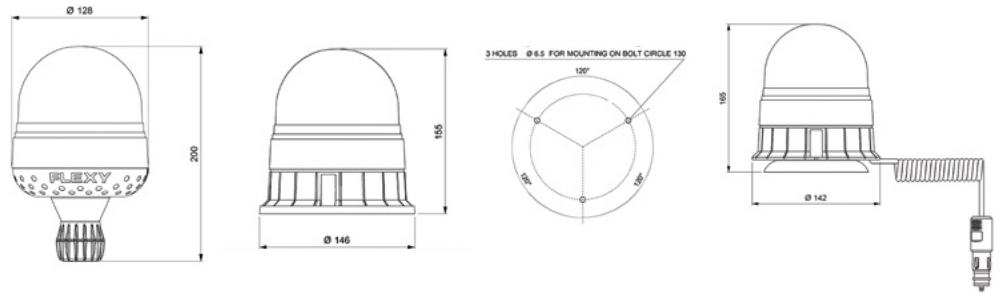

D14508
(21.87.L75.3V8)



D14507
(21.87.L35.3V8)



D14509
(21.87.LV5.3V8)



D14510
(21.87.815.RTV)

cabochon - lens - Lichtscheibe

Montage sur tige
DIN pole mounting
Für Aufsteckrohr

Fixation à visser
Screw mounting
Schraubbefestigung

Magnétique
Magnetic
Magnetfuss

ROTA LED Rotatif
LED Rotative
Rotierend LED

FLASH LED à éclats
LED Flash
Blitze LED

TAURUS LED



LED

10/30V
9 W

✓ R65 ✓ R10

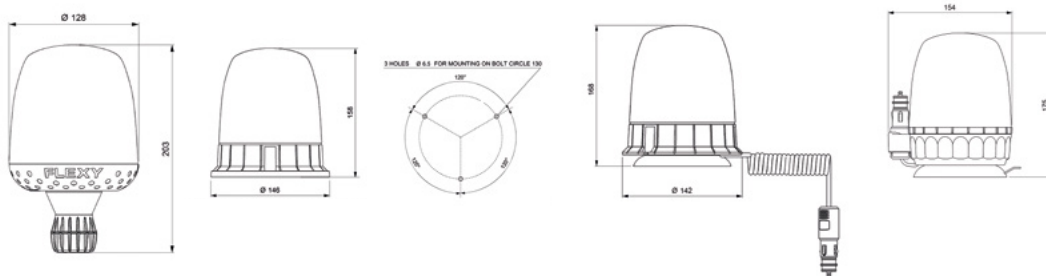

FLEXI

D14483
(21.48.L75.3V8)



D14482
(21.48.L35.3V8)



D14485
(21.48.LV5.3V8)



D14484
(21.48.LR5.3V8)

ROLL CABLE



D14734
(21.48.LR5.15V)

ROLL CABLE



FLEXI

D14733
(21.48.L75.15V)



D14732
(21.48.L35.15V)



D14735
(21.48.LV5.15V)



D14486
(2148.815.RTV)

cabochon - lens - Lichtscheibe



D14736
(2148.855.LMV)

cabochon - lens - Lichtscheibe

SATURNELLO LED



LED

10/30V
9 W

✓ R65 ✓ R10

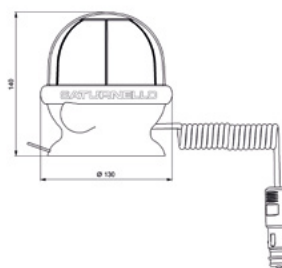

FLEXI

D14737
(21.88.L85.3V8)



D14738
(21.88.LV5.3V8)



D14739
(21.88.815.VLG)

cabochon - lens - Lichtscheibe

MINI SATURNELLO LED



LED

10/30V
9 W

✓ R65 ✓ R10

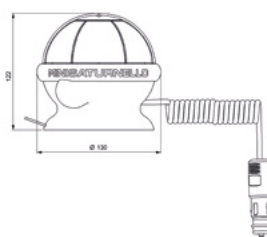
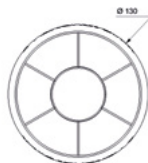

FLEXI

D14740
(21.83.L85.3V8)



D14741
(21.83.LV5.3V8)



D14742
(21.83.815.VLG)

cabochon - lens - Lichtscheibe

Gyrophares - Beacons - Rundumkennleuchten

PUCK



LED

10/30V
3,5 W

R10

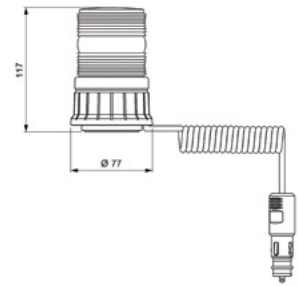
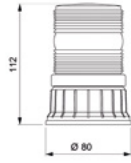
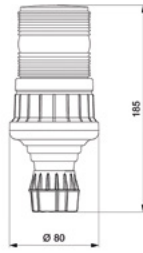

FLEXI

D14453
(21.38.L75.2VL)



D14451
(21.38.L35.2VL)



D14452
(21.38.LM5.2VL)



COMPACT - KOMPAKT



FRESNEL



LED

10/110V
3,5 W

R10

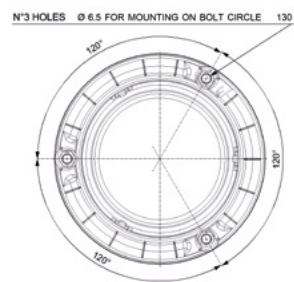
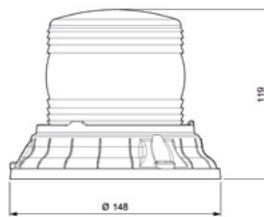

D14746
(21.37.L35.2VL)

AUTONOMOUS

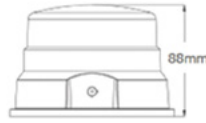
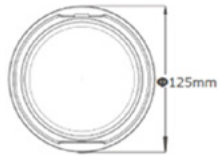

LED

10/30V
9 W

✓ R65 ✓ R10



NEW



D16012
(SM FL 104.OR.AUT)



Magnétique et sur batterie rechargeable, Câble de rechargement fourni.

Magnetic and rechargeable battery, recharging cable included.

Magnetisch und auf wiederaufladbarer Batterie, aber auch Screenshots machen.
Ladekabel enthalten.

WARNING SIGNAL



LED

NEW



D16028



Magnétique et sur batterie rechargeable, Câble de rechargement fourni.

Magnetic and rechargeable battery, recharging cable included.

Magnetisch und auf wiederaufladbarer Batterie, aber auch Screenshots machen.
Ladekabel enthalten.

TAURUS



H21W

12/24V
23W



lampes 12/24V fournies
- 12/24V bulbs included -
inklusive Glühlampen 12/24V

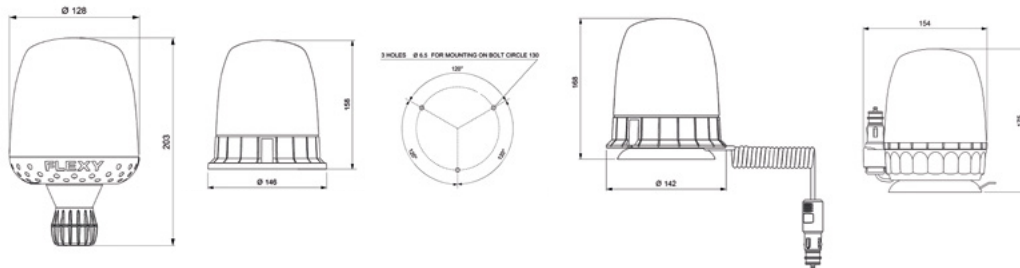

FLEXI

D14470
(21.48.H75.VLG)



D14467
(21.48.H35.VLG)



D14468
(21.48.HV5.VLG)



D14469
(21.48.HR5.VLG)



ROLL CABLE



D14471
(21.48.811.VLG)

cabochon - lens - Lichtscheibe

VEGA



H1

12/24V
55-70W



lampes 12/24V fournies
- 12/24V bulbs included -
inklusive Glühlampen 12/24V

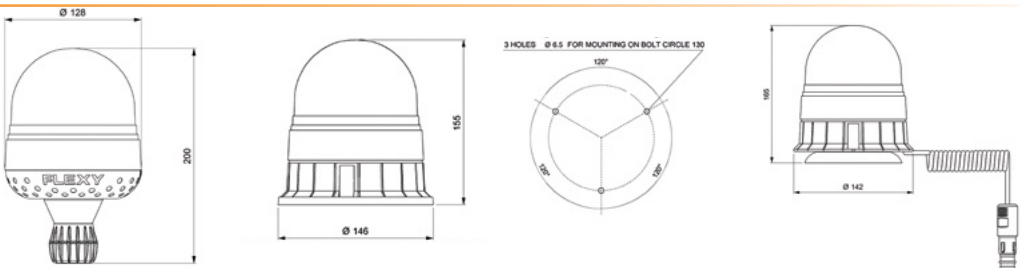

D14479
(21.87.T75.VLG)



D14477
(21.87.T35.VLG)



D14478
(21.87.TV5.VLG)



D14480
(21.87.811.VLG)

cabochon - lens - Lichtscheibe



Exemple de montage - Assembly suggestion - Montagebeispiel



D14514
(21.92.000.VLG)

tige avec support central - socket with central clamp - Aufsteckrohr mit zentralem Tragbuegel
ISO 4148/4165



D14513
(21.91.000.VLG)

tige à visser - socket to be screwed Aufsteckrohr zum Anschrauben
ISO 4148/4165

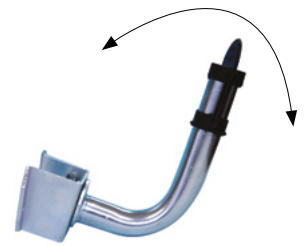

D14515
(21.97.005.VLG)

tige articulée 360° - 360° rotating socket - Bewegbarer Aufsteckrohr 360°
ISO 4148/4165



D14511
(21.76.282.VLG)

semelle plate - flat gasket - Flache Sockeldichtung



D14512
(21.76.283.VLG)

semelle inclinée - tilted gasket - Gekippte Sockeldichtung



Exemple de montage - Assembly suggestion - Montagebeispiel

STELLAR



LED

10/36V

R65

R10

SAE



IP6K9K



Performance lumineuse homologuée R65

R65 approved light performance
R65-geprüfte Lichtleistung

Design extra plat et aérodynamique

Extra flat and aerodynamic design
Extra flaches und aerodynamisches Design

Qualité «best in class» constructeurs

Best in class manufacturer quality
Best-In-Class Herstellerqualität

Polycarbonate ultra robuste

Ultra robust polycarbonate
Extrem robustes Polycarbonat



VIDEO YOUTUBE

Autres options et versions disponibles sur demande :

- Bleu véhicules prioritaires et d'urgences
- Phares de travail avant, arrière, latéraux
- Rappel stop, position, indicateur de direction
- Traffic master
- Interface véhicule mécanique et électronique
- Centre blanc opaque avec texte

Other options and versions available on request:

- Blue priority and emergency vehicles
- Work lights and alley lights
- Additional stop, position, direction indicator
- Traffic master
- Mechanical and electronic vehicle interface
- White opaque center with text

Weitere Optionen und Versionen auf Anfrage:

- Blaue Einsatz- und Notfallfahrzeuge
- Arbeitsscheinwerfer und Gassenlichter
- Zusätzlicher Bremslicht, Positionslicht, Richtungsanzeiger
- Verkehrsleitsystem
- Mechanische und elektronische vehicle Schnittstelle
- Zentrum opak weiß mit Text

STELLAR



LED



10/36V



IP6K9K

Câble fils nus - naked cable
extremity - Kabellitze



D23301 950 mm

R65 ambre - amber - Gelb



D23401 1250 mm

R65 ambre - amber - Gelb



D23501 1550 mm

R65 ambre - amber - Gelb



D23513 1550 mm

R65 ambre - Stop/Position/Indicateur de direction - Phares de travail avant et latéraux
R65 amber - Stop/Position/Direction indicator - Front and alley work lights
Gelb-R65 - Schluss-/Bremslicht/Blinker - Alley lights - Arbeitsscheinwerfer vorne

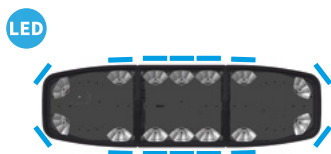

D23354 950 mm

R65 bleu - blue - Blau

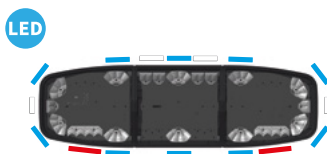

D23363 950 mm

R65 bleu - Stop/Position/Indicateur de direction - Phares de travail avant et latéraux
R65 blue - Stop/Position/Direction indicator - Front and alley work lights
Blau-R65 - Schluss-/Bremslicht/Blinker - Alley lights - Arbeitsscheinwerfer vorne



D16058



D16035

Triflash



LED à éclats
LED Flash
Blitze LED



Polycarbonate
Polycarbonate
Polycarbonat



Pièces détachées
Spare parts
Ersatzteile



Flashez le QR code pour plus d'infos
Scan the QR code for more info
Scannen Sie den QR-Code für weitere Informationen



Indice de protection IP - solides/liquides
IP ingress protection - solids/liquids
IP Schutzfaktor - Fremdkörper/Wasser



Homologation circulation réseau routier public
Approval circulation on public road network
Genehmigung des öffentlichen Straßennetzes



Homologation CEM - compatibilité électromagnétique
EMC approval - Electromagnetic Compatibility
EMV zulassung - Elektromagnetische Verträglichkeit

TRIFLASH 500 CEA



LED

10/30V
9,5 W

R10 NF EN 12352

PC/ABS

IP6K9K

< 3,5t



* kit de relevage manuel inclus - manual lift kit included - manueller Aufzug inklusive

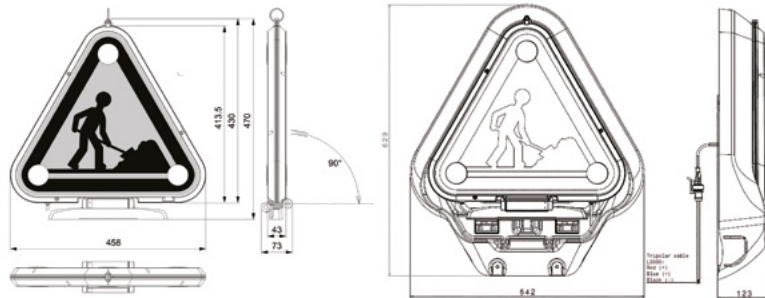

Symbole AK5 - Compact - Léger (3,15 Kg) - Homologué
AK5 symbol - Compact - Light (3,15 Kg) - Approved
AK5-Symbol - Kompakt - Leicht (3,15 kg) - Zugelassen



D14760 *
(2090L51200)



Classe 1 : ville et route nationale - town and trunk roads - Stadt und Landstrassen



D14762 *
(2090L52200)



Classe 2 : autoroutes et voies rapides - highways - Autobahnen und Schnellstrassen

NEW

ELEC



D14925
(2090L5220E)



Classe 2 : autoroutes et voies rapides - highways - Autobahnen und Schnellstrassen

TRIFLASH 700 CEA



LED

10/30V
9,5 W

R10 NF EN 12352

PC/ABS

IP6K9K

> 3,5t



* kit de relevage manuel inclus - manual lift kit included - manueller Aufzug inklusive



D14926 *
(2090L72200)



Classe 2 : autoroutes et voies rapides - highways - Autobahnen und Schnellstrassen

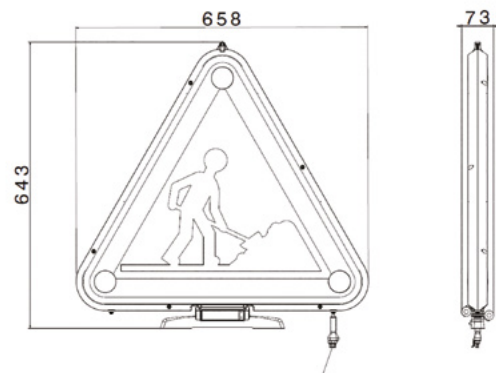

TRIFLASH ACC CEA



LED

10/30V
9,5 W

✓ R65 ✓ R10



IP6K9K

Exemple de montage D14762 + D14930
Assembly suggestion D14762 + D14930
Montagebeispiel D14762 + D14930



D14932
(2090L1B110)

Pour Triflash avec 1 gyrophare LED
For Triflash with 1 LED beacon
Für Triflash mit 1 LED rundumkennleuchte

D14933
(2090L1B136)

Pour Triflash avec 1 gyrophare LED
For Triflash with 1 LED beacon
Für Triflash mit 1 LED rundumkennleuchte

D14934
(2090L1B151)

Pour Triflash avec 1 gyrophare LED
For Triflash with 1 LED beacon
Für Triflash mit 1 LED rundumkennleuchte



D14929
(2090L2B110)

Pour Triflash avec 2 gyrophares LED
For Triflash with 2 LED beacons
Für Triflash mit 2 LED rundumkennleuchten

D14930
(2090L2B136)

Pour Triflash avec 2 gyrophares LED
For Triflash with 2 LED beacons
Für Triflash mit 2 LED rundumkennleuchten

D14931
(2090L2B151)

Pour Triflash avec 2 gyrophares LED
For Triflash with 2 LED beacons
Für Triflash mit 2 LED rundumkennleuchten



D14935
(2090L2B181)

Pour Triflash avec 2 gyrophares LED
For Triflash with 2 LED beacons
Für Triflash mit 2 LED rundumkennleuchten



D14928
(2090805000)

Kit de relevage manuel pour - manual lift kit for - manueller Aufzug für
D14760 - D14762 - D14926



D14922
(209080U000)

Support universel - Pattes de fixation pour barre Triflash.
Universal bracket - Mounting brackets for Triflash bar
Universalhalterung - für Triflash- Dachträger



D14989
(2090804000)

Kit de fixation sur barre pour Triflash électrique D14925.
Bar mounting kit for electric Triflash D14925.
Stangenmontage-Kit für elektrischen Triflash D14925.

TLP 500 SESALY



Symbole AK5 - Haute intensité lumineuse - référencé chez Orange, Ville de Paris, EDF, GDF, SNCF
 AK5 symbol - High luminous intensity - chosen by major energy and transportation fleets
 AK5-Symbol - Hohe Lichtstärke - ausgewählt von großen Energie- und Transportflotten

LED

12/24V
3,2 W

R10 NF EN 12352



IP6K9K

< 3,5t

NEW



D16001
(TLP 500 CL2)



Classe 1 : ville et route nationale - town and trunk roads - Stadt und Landstrassen

NEW

ELEC



D16003
(TLP 500-ELEC.CL2)



Classe 2 : autoroutes et voies rapides
- highways - Autobahnen und Schnellstrassen

NEW



Ref sur demande
P/N on request - Artikelnummer auf Anfrage

TLP 700 SESALY



NEW

LED

10/30V
9,5 W

R10

PC/ABS



IP6K9K

>3,5t



D16034
(TLP 700 CL2)



Classe 2 : autoroutes et voies rapides
- highways - Autobahnen und Schnellstrassen

Feux de pénétration

Directional lights

Warnleuchten



Flashez le QR code pour plus d'infos
Scan the QR code for more info
Scannen Sie den QR-Code für weitere Informationen



Indice de protection IP - solides/liquides
IP ingress protection - solids/liquids
IP Schutzfaktor - Fremdkörper/Wasser



Pièces détachées
Spare parts
Ersatzteile



Homologation circulation réseau routier public
Approval circulation on public road network
Genehmigung des öffentlichen Straßennetzes



Homologation CEM - compatibilité électromagnétique
EMC approval - Electromagnetic Compatibility
EMV zulassung - Elektromagnetische Verträglichkeit



Polycarbonate
Polycarbonate
Polycarbonat

Feux de pénétration - Directional lights - Warnleuchten

SESA PULSAR



LED

12/24V
5,5 W

R65

R10



IP69K

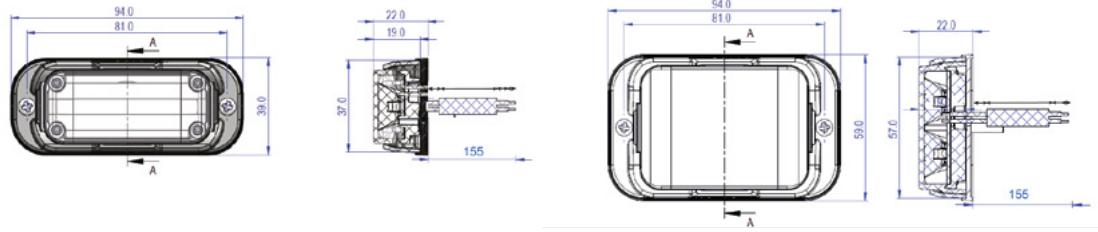

NEW

NEW

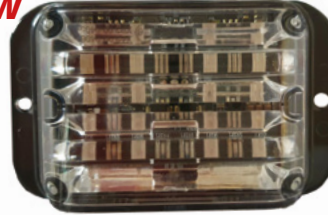
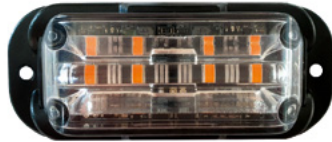

ECE R65-Class 1

ECE R65-Class 2

- D16004 ●
- D16056 ○
- D16005 ●
- D16075 ●

- D16018 ●
- D16017 ●
- D16076 dual color ● ●

Single (120 flash/min)	Double (120 flash/min)
Quad (120 flash/min)	Cruise

4 types de flash
4 flash patterns
4 Blitzmuster

DL LONG



LED

10/30V
12 W

R65 ● ●

R10 ● ○ ●



IP67

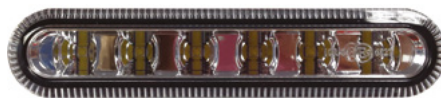
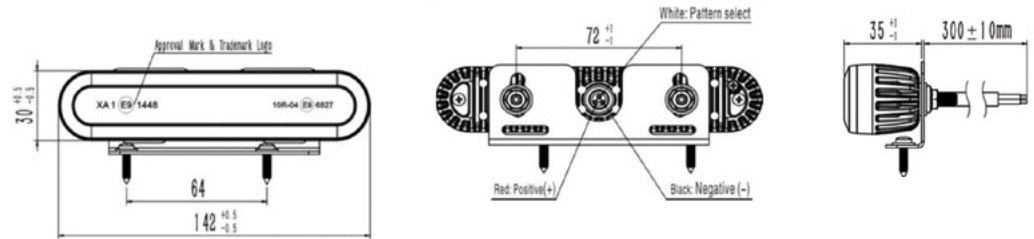

- D14190 ●
- D14354 ○
- D14353 ●

One Flash (600ms)	In turn Double Flash (800ms)
In turn 4 Flash (800ms)	3 Flash (600ms)
5 Flash (1000ms)	1 Flash (960ms)
In turn 3 Flash (600ms)	Unique (410ms)
Frequent Flash (60ms)	Combination

10 types de flash
10 flash patterns
10 Blitzmuster

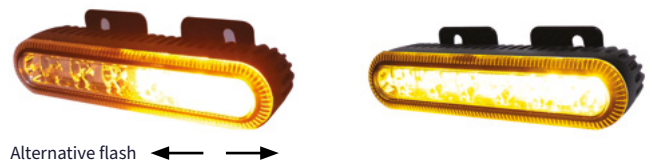

GUARDIAN ANGEL



LED

360°



IP68



NEW



D16038



NEW



D16039

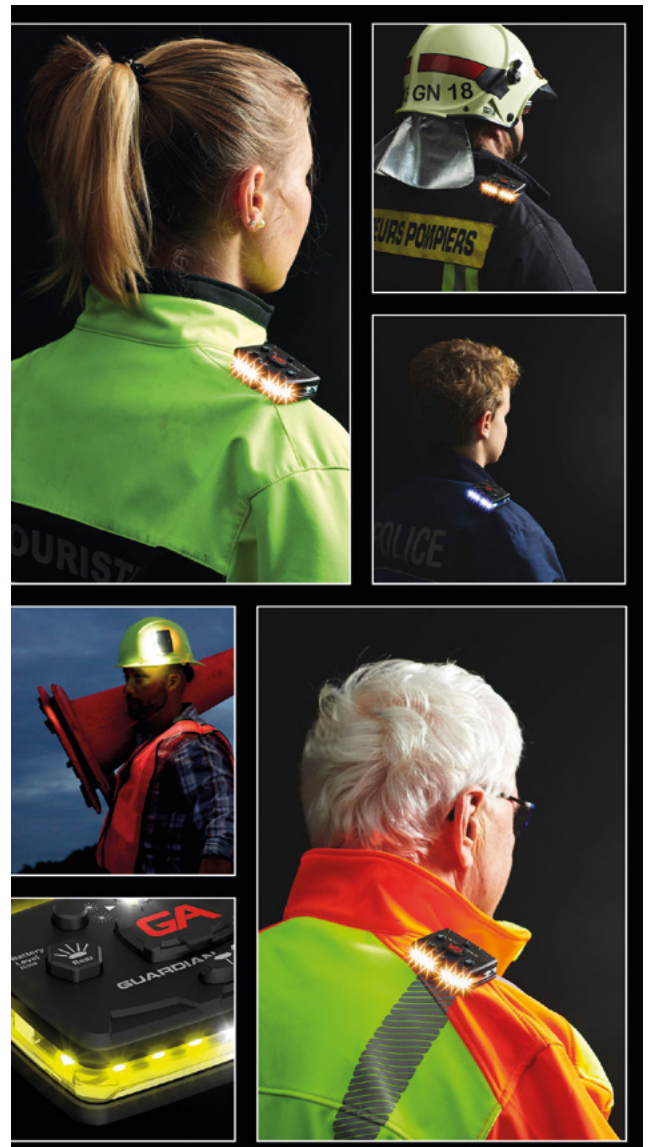

Alarmes sonores de recul

Back-up alarms

Rückfahrwarner



Standard



Multi-Frequency



Flashez le QR code pour plus d'infos
Scan the QR code for more info
Scannen Sie den QR-Code für weitere Informationen



Indice de protection IP - solides/liquides
IP ingress protection - solids/liquids
IP Schutzfaktor - Fremdkörper/Wasser



Pièces détachées
Spare parts
Ersatzteile



Homologation CEM - compatibilité électromagnétique
EMC approval - Electromagnetic Compatibility
EMV zulassung - Elektromagnetische Verträglichkeit

ASR



STANDARD - HERKÖMMLICH

102 mm x 71 mm x 41 mm

Standard



1. Chariots élévateurs, petits camions, VUL
Forklifts, small trucks, LCV
Gabelstapler, Lieferwagen, Transporter
2. Toute utilisation. Ajustement automatique 10 db supérieur au bruit ambiant
All use. Automatic adjustment 10dB higher than the environment noise
Alle Anwendungsbereiche. Automatische Lautstärkeanpassung +10db über Umgebungslärm
3. Benne à ordure, chantier, forêt, PL
Waste collection vehicles, forest work vehicles, trucks
Müllfahrzeuge, Baustellenfahrzeuge, Forstfahrzeuge, LKW



12/24V



630120 : SAE Type D
630100 : SAE Type F
D13807 : SAE Type D
D13808 : SAE Type C

1	630120	87 db
2	630110	82-102 db
3	630100	102 db



IP65

MULTI-FRÉQUENCE - MULTI-FREQUENCY - MEHRFACHFREQUENZ

102 mm x 71 mm x 41 mm

Multi-Frequency



D13807	87 db
D13808	97 db

Multi-Frequency



D13810	97 db 1500 mm
---------------	------------------

CLICK-IN



24V

MULTI-SON - MULTI-SOUND

NEW



D16074	97 db
---------------	-------

Multi-frequence ou standard
Multi-frequency or standard
Mehrfachfrequenz oder herkömmlich

Alarmes sonores de recul - Back-up alarms - Rückfahrwarner

ASR



INTÉGRÉE - BUILT-IN - EINGEBAUT

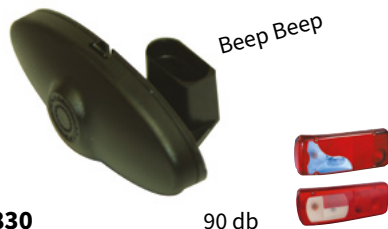

001830

90 db

Pour connection sur feu arrière LC8 p. 150
To plug in LC8 rear lamp p. 150
Zum direkten Anschluss an die Heckleuchte LC8 S. p. 150



001872

55-90db

Ajustement bruit ambiant sur feu arrière LC8 MAN p. 153
Environment noise adjustment MAN LC8 rear lamp p. 153
Automatische Umgebungslärm Heckleuchte MAN LC8 S. p. 153

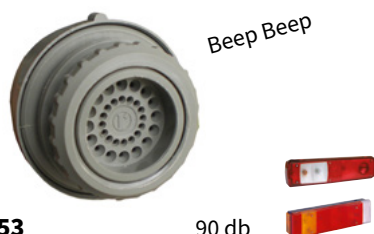

D12953

90 db

Pour connection sur feu arrière LC9 p. 160, LC7 p. 166
To plug in LC9 / LC7 rear lamp p. 160 / p. 166
Zum direkten Anschluss an die Heckleuchte LC9 S. p. 160, LC7 S. p. 166

SESA TUNES ADVANCED - AVAS



AVAS

FMVSS141
R138



Son AVAS homologué R138

R138-approved AVAS sound
R138-zugelassener AVAS-Ton

Idéal véhicules hybrides et électriques

Ideal for hybrid and electric vehicles
Ideal für Hybrid- und Elektrofahrzeuge

Niveau de son ajustable et personnalisable

Adjustable and customizable sound level
Einstellbarer und anpassbarer Tonpegel

Multifonctions : Son AVAS, alarme de recul, gong piéton

Multifunction: AVAS sound, reversing alarm, pedestrian gong
Multifunktional: AVAS-Sound, Rückfahrwarner, Fußgänger-Gong

Systèmes caméra

Camera systems

Kamera-Systeme

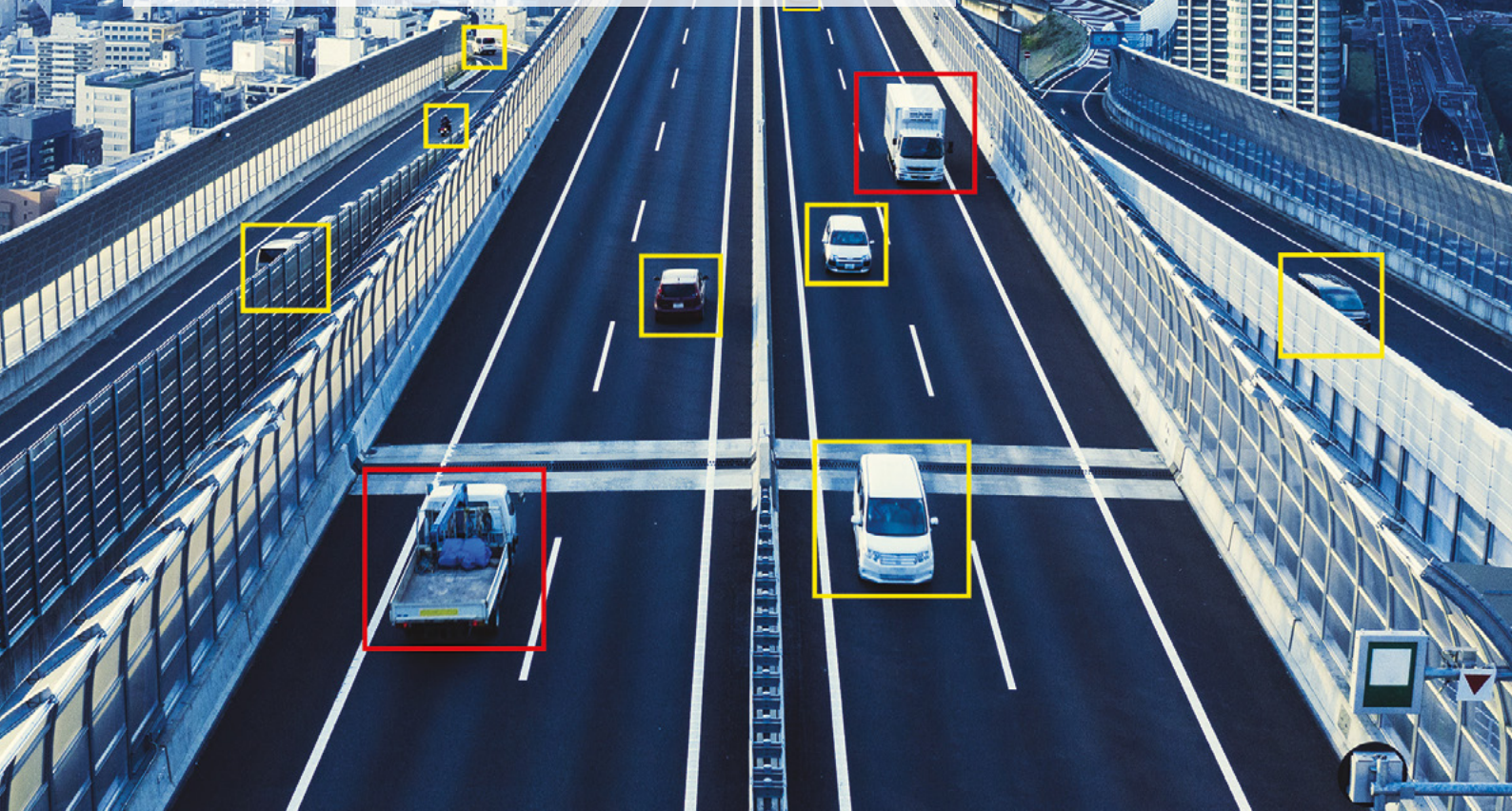

Systèmes sans fil - Wireless Systems - Drahtlose systeme

p. 244-245



Systèmes filaires - Wired systems - Verdrahtete systeme

p. 246-250



Flashez le QR code pour plus d'infos
Scan the QR code for more info
Scannen Sie den QR-Code für weitere Informationen



Système HD
HD system
HD systeme



Indice de protection IP - solides/liquides
IP ingress protection - solids/liquids
IP Schutzfaktor - Fremdkörper/Wasser



Écran tactile
Touch screen
Berührungsbildschirm



Pièces détachées
Spare parts
Ersatzteile



Caméra vision nocturne
Night vision camera
Nachtsichtkamera



Taille écran
Screen size
Bildschirmgröße



Écran fractionné
Split screen
geteilter Bildschirm



Système sans fil
Wireless system
Drahtlose systeme

CAM WIRELESS HD 2.4 GHz 7"



NEW



D16044

12/24V - Ecran fractionné couleur 7 pouces - transmission sans fil 2.4 GHz 300 m - Raccordement jusqu'à 4 caméras - **appairage automatique** - Enregistrement en temps réel - Support carte micro SD (non fournie) - Caméra micro intégré - vision de nuit - Utilisation entre -20°C et +70°C

12/24V - 7 inch colour quad screen - 300 m wireless transmission 2.4 GHz - connecting up to 4 wireless cameras - **Auto scan** - Real time recording - Support SD card - Camera with micro integrated - night vision - Use between -20°C and +70°C

12/24V - 7" Farbbildschirm - 300 m-Übertragungsfrequenz 2,4 GHz - bis zu 4 drahtlose Kameras anschließbar - **Automatischer Abgleich** - Echtzeitaufnahme - SD Karten Aufnahme - Nachtsichtkamera mit integriertem Mikrofon - Betriebstemperatur -20°C bis +70°C



TEMPS D'ENREGISTREMENT - RECORDING TIME - AUFNAHMEZEIT :

MODE \ Micro SD	16G	32G	64G	128G
SINGLE (640x480x1)	≈ 15h	≈ 30h	≈ 60h	≈ 120h
QUAD (320x240x4)	≈ 17h	≈ 34h	≈ 68h	≈ 136h
SPLIT (400x480x2)	≈ 18h	≈ 36h	≈ 72h	≈ 144h

NOTICE DE BRANCHEMENT - CONNECTION INSTRUCTIONS - ANSCHLUSSANWEISUNGEN :



rouge positif - red positive - rot positiv
 noir masse - black ground - schwarz Erdung
 marron recul - brown reverse - Braun Zurückfahren
 blanc clignotant gauche - white left indicator - Weiß Blinker links
 bleu clignotant droit - blue right indicator - Blau Blinker rechts
 vert ou jaune option - green or yellow trigger option - grüne oder gelbe Triggeroption



Les appareils 2.4 GHz tels que les téléphones cellulaires, les systèmes Bluetooth et Wi-Fi peuvent causer des interférences passagères. 2.4 GHz devices such as mobile phones, Bluetooth and Wi-Fi may cause some temporary interferences. Bei gleichzeitigem Betrieb von Geräten, die im Frequenzbereich von 2,4 GHz arbeiten, wie z.B. Mobiltelefone, Bluetooth und WLAN Übertragungen, können gelegentlich Störinterferenzen auftreten.

ACC WIRELESS HD



COMPOSEZ VOTRE KIT SUR-MESURE

BUILD YOUR OWN CUSTOM KIT

STELLEN SIE SICH IHR KIT MASSGESCHNEIDERT ZUSAMMEN



1. ECRAN - MONITOR - FARBBILDSCHIRM

NEW



D16055

Ecran 7" - 7" screen - 7" Farbbildschirm
Fractionnable - Multi display - Teilbar



2. CAMÉRA - CAMERA - KAMERA

NEW

130°



D16045

Aluminium
Aluminum
Aluminium

NEW

130°



D16046

batterie rechargeable
rechargeable battery
Akku

NEW

130°



D16126

Capot motorisé
Motorized - Auto-shutter
Motorisierte Auto-shutter



3. ACCESSOIRES - ACCESSORIES - ZUBEHÖR



D14063

7 m



D14326

antenne écran - screen antenna
- Bildschirmantenne



D14195

antenne caméra - camera
antenna - Kameraantenne



Exemple de montage - Assembly suggestion - Montage-
beispiel
Kit D16044 + D16045 x 3

CAM WIRED HD 720P 7"



100°



20 m

NEW

D16033



12/24V - Ecran couleur 7 pouces - Raccordement possible pour 3 caméras - Caméra LED micro intégré avec - vision de nuit - Utilisation entre -20°C et +70°C

12/24V - 7 inch colour screen - Connection possible for 3 cameras - LED aluminium/stainless steel camera with micro integrated - night vision - Use between -20°C and +70°C

12/24V - 7" Farbbildschirm - bis zu 3 Kameras anschließbar - LED - Nachtsichtkamera mit integriertem Mikrofon - Betriebstemperatur -20°C bis +70°C

NOTICE DE BRANCHEMENT D16033 - CONNECTION INSTRUCTIONS - ANSCHLUSSANWEISUNGEN :

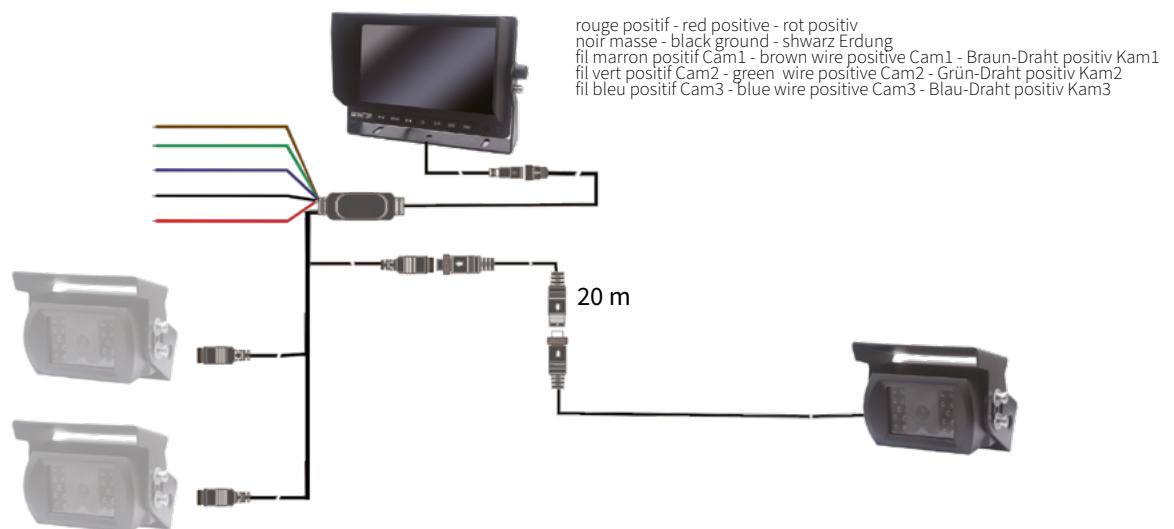

ACC WIRED



100°



D16043

Aluminium
Aluminum
Aluminium

150°



D14148

Slim grand angle
Slim wide angle
Slim 150° winkel

120°



D14327

Motorisée + chauffante
Motorized + auto heater
Motorisierte + Heizung



D13620



D13621

10 m

D13622

20 m



Exemple de montage - Assembly suggestion - Montagebeispiel
Kit D16033 + D13621 + D13620

CAM WIRED 720P AUTO SHUTTER 7"

 12/24V
10W

 R10

 
IP69K

 
7" HD 720P





20 m

NEW

D16131

12/24V - Ecran couleur 7 pouces - Raccordement possible pour 3 caméras - Caméra LED avec capot motorisé et micro intégré - vision de nuit - Utilisation entre -20°C et +70°C

12/24V - 7 inch colour screen - Connection possible for 3 cameras - LED aluminium camera with auto-shutter and micro integrated - night vision - Use between -20°C and +70°C

12/24V - 7" Farbbildschirm - bis zu 3 Kameras anschließbar - LED - Nachtsichtkamera mit integriertem Auto-shutter und Mikrofon - Betriebstemperatur -20°C bis +70°C



ACC WIRED

 12/24V

HD 720P

 120°



D16132

Capot motorisé
Motorized - Auto-shutter
Motorisierte Auto-shutter



D13620



D13621

10 m

D13622

20 m



CAM WIRED HD 1080P 7"



12/24V



IP69K



NEW

20 m

D16129



12/24V - Qualité d'image HD 1080P - Ecran quad HD 7" fractionnable - Raccordement jusqu'à 4 caméras - Caméra LED aluminium avec micro intégré - vision de nuit - Utilisation entre -20°C et +70°C

12/24V - 720P HD image quality - 7" quad HD screen Multi display - Connecting up to 4 cameras - LED aluminium camera with micro integrated - night vision - Use between -20°C and +70°C

12/24V - 720P HD-Bildqualität - 7" Quad HD-Farbbildschirm Teilbar - bis zu 4 Kameras anschließbar - LED - Nachtsichtkamera aus Edelstahl mit integriertem Mikrofon - Betriebstemperatur -20°C bis +70°C

CAM WIRED HD 1080P 10"



12/24V



IP69K



NEW

20 m

D16130



12/24V - Qualité d'image HD 1080P - Ecran quad HD 10" fractionnable - Raccordement jusqu'à 4 caméras - Caméra LED aluminium avec micro intégré - vision de nuit - Utilisation entre -20°C et +70°C

12/24V - 720P HD image quality - 10" quad HD screen Multi display - Connecting up to 4 cameras - LED aluminium camera with micro integrated - night vision - Use between -20°C and +70°C

12/24V - 720P HD-Bildqualität - 10" Quad HD-Farbbildschirm Teilbar - bis zu 4 Kameras anschließbar - LED - Nachtsichtkamera aus Edelstahl mit integriertem Mikrofon - Betriebstemperatur -20°C bis +70°C

ACC WIRED HD 1080P



12/24V

1. ECRAN - MONITOR - FARBBILDSCHIRM



D16134

Ecran quad HD 7" fractionnable - 7" quad HD screen Multi display - 7" Quad HD-Farbbildschirm Teilbar



D16135

Ecran quad HD 10" fractionnable - 10" quad HD screen Multi display - 10" Quad HD-Farbbildschirm Teilbar



D16133

Aluminium - Aluminum - Aluminium

3. CÂBLAGE - WIRING - VERKABELUNG



D13620

Pour 1 caméra HD720P - For 1 HD 720P camera - Für 1 HD720P Kamera



D14685

Pour 2 caméras HD - For 2 HD cameras - Für 2 HD Kameras



D13621

10 m

D13622

20 m



5054

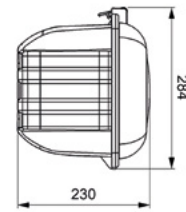
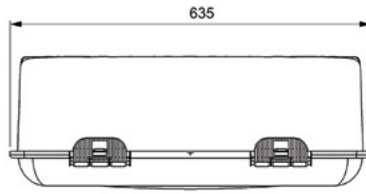

Max 6 kg

D14538
(50.52.925.TV2)

Avec sangle nylon - with nylon strap - mit nylon Riemen



Max 6 kg

D14539
(50.52.925.TVC)

Avec sangle CLIP réglable - with adjustable CLIP strap - mit verstellbaren Riemen CLIP



NEW



Max 6 kg

D16163

Coffres porte extincteur - Extinguisher boxes - Feuerlöscherbehälter

5051

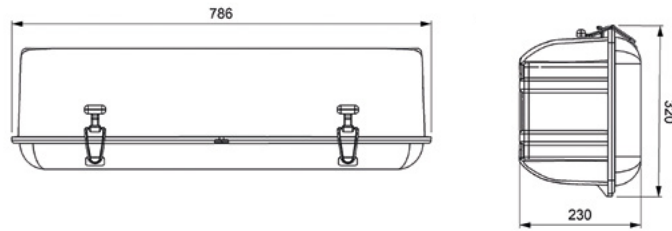

Max 9 kg

D14537
(50.51.020.VLG)

Avec sangle plastique - with plastic strap -
mit Kunststoff Riemen

NEW



Max 9 kg

D16162

FIRE EXTINGUISHER



D16036

Inhibiteur de feu ultra compact - durée d'émission 50 secondes - durée de vie illimité (sans date de péremption) - sans entretien périodique

Ultra compact fire extinguisher - emission time 50 seconds - unlimited service life (no expiry date) - no periodic maintenance

Ultrakompakter Feuerlöscher - Löschzeit 50 Sekunden - unbegrenzte Lebensdauer (ohne Verfallsdatum) - ohne regelmäßige Wartung

Prises et câbles spiralés

Plugs and coils

Stecker und Spiralkabel



Flashez le QR code pour plus d'infos
Scan the QR code for more info
Scannen Sie den QR-Code für weitere Informationen

7P



24V

24N (ISO 1185)
24S (ISO 3731)

MÉTALLIQUE - METAL - METALL



D10873

24N



611530

24N



D10874

24S



611550

24S

PLASTIQUE - PLASTIC - KUNSTSTOFF



611500

24N



611580

24N



611510

24S



611590

24S



611520

24N



611540

24S

C7P



Longueur de travail : L
Working length : L
Arbeitslänge : L

LMax
Longueur d'extension maximale
Maximum extension length
Maximale Ausziehlänge

MÉTALLIQUE - METAL - METALL



D14313 24N LMax 3,5 m

611140 L : 3 m, LMax 4,5 m



D14314 24S LMax 3,5 m

611150 L : 3 m, LMax 4,5 m

PLASTIQUE - PLASTIC - KUNSTSTOFF



D14312 24N LMax 3,5 m

611070 L : 3 m, LMax 4,5 m



D14316 24S LMax 3,5 m

611080 L : 3 m, LMax 4,5 m

EURO6

D14574 L : 3 m, LMax 4,5 m

D14575 L : 3 m, LMax 4,5 m

EURO6

6 x 1,0 mm² + 1 x 1,5 mm²



611110 24N/24S

24N

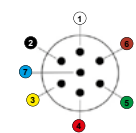

- ① - Masse
- ② - Feu de position G
- ③ - Clignotant G
- ④ - Feu Stop
- ⑤ - Clignotant D
- ⑥ - Feu de position D,
- ⑦ - Commande de frein

- Common return
- L rear position lamp
- L flasher lamp
- Stop lamp
- R flasher lamp
- R rear position lamp,
- Breaking control

- Masse
- Linke Schlussleuchte
- Fahrrichtungsanzeiger links
- Bremsleuchte
- Fahrrichtungsanzeiger rechts
- Rechte Schlussleuchte
- Steuerung Anhängerbremse

24S

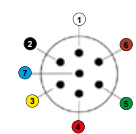

- ① - Masse
- ② - Sans affectation
- ③ - Feu de recul
- ④ - Alimentation en puissance
- ⑤ - Sans affectation
- ⑥ - Sans affectation
- ⑦ - Feu AR de brouillard

- Common return
- Without affectation
- Reverse lamp
- Power supply
- Without affectation
- Without affectation
- Fog lamp

- Masse
- Nicht belegt
- Rückfahrleuchte
- Stromversorgung (Dauerplus)
- Nicht belegt
- Nicht belegt
- Nebelschlussleuchte

15P



24V

ISO 12098



A10060



A10061



D14315 LMax 3,5 m

D11578 L : 3 m, LMax 4,5 m

D14577 L : 3 m, LMax 4,5 m **EURO6**

7P-15P



24V



D11487 L : 3 m, LMax 4,5 m

D14824 LMax 3,5 m



D14689 L : 3 m, LMax 4,5 m

EURO6 **D14578** L : 3 m, LMax 4,5 m

D14802 LMax 3,5 m



D13889



A10064

ABS/EBS



ISO 7638-1



611560 ABS/EBS



A10062 ABS/EBS



A10065 ABS/EBS

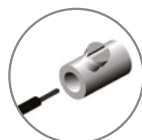

A10066 ABS/EBS



D14311 LMax 3,5 m ABS/EBS 5P

D10597 L : 3 m, LMax 4,5 m ABS/EBS 7P

D14576 L : 3 m, LMax 4,5 m ABS/EBS 7P **EURO6**



611570 PARC ABS/EBS-15P

ABS/EBS



- | | | |
|---|--------------------|--------------------|
| ⊕ - Plus (+) alimentation électrovanne | Plus electrovalve | Plus Magnetventil |
| ⊕ - Plus (+) connexions électroniques | Plus electronics | Plus Elektronik |
| ⊖ - Moins (-) connexions électroniques | Minus electronics | Minus Elektronik |
| ⊖ - Moins (-) alimentation électrovanne | Minus electrovalve | Minus Magnetventil |
| ⊙ - Connexion lampe témoin | Warning device | Warneinrichtung |
| Ⓜ - Connexion donnée CANH | CANH | Datenleitung CANH |
| Ⓝ - Connexion donnée CANL | CANL | Datenleitung CANL |

15 PÔLES



- | | | |
|--------------------------------------|----------------------------|---|
| ① - Clignotant gauche | L flasher lamp | Fahrtrichtungsanzeiger links |
| ② - Clignotant droit | R flasher lamp | Fahrtrichtungsanzeiger rechts |
| ③ - Feu AR de brouillard | Fog lamp | Nebelschlussleuchte |
| ④ - Masse | Common return | Masse |
| ⑤ - Feu de position gauche | L rear position lamp | Linke Schlussleuchte |
| ⑥ - Feu de position droit | R rear position lamp | Rechte Schlussleuchte |
| ⑦ - Feu stop | Stop lamp | Bremsleuchte |
| ⑧ - Feu de recul | Reverse lamp | Rückfahrleuchte |
| ⑨ - Alimentation 24V | 24V power supply | Stromversorgung +24V |
| Ⓜ - Capteur d'usure des freins | Worn brake indicator | Sensor für Bremsbelagverschleissanzeige |
| ⑪ - Capteurs de pressions des freins | Brake pressure collector | Anzeige für Federspeicherbremse |
| ⑫ - Dispositif de levage d'essieu | Adjustable suspension lift | Achsanhebung |
| ⑬ - Masse pour contacts 14 et 15 | Common return | Masse für Datenleitungen |
| ⑭ - Bus de données | Data line | Datenleitung |
| ⑮ - Bus de données | Data line | Datenleitung |

USBA.RBL



12/24V

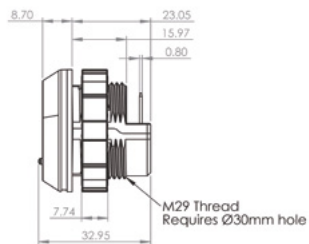

NEW



D16007

NEW



D16100

USBA.3.APL



12/24V

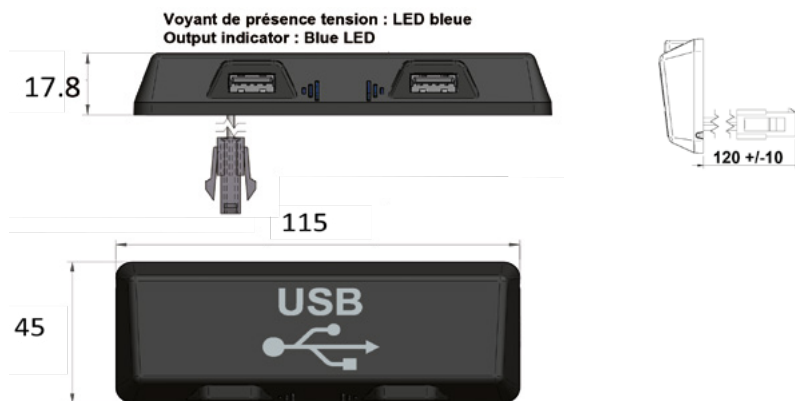

NEW



D16099

Connecteurs Connectors Anschlussstecker

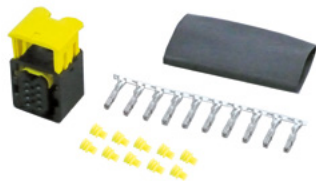

Flashez le QR code pour plus d'infos
Scan the QR code for more info
Scannen Sie den QR-Code für weitere Informationen

AMP 1.5-7P-M

Type connecteur - Nb pins - Mâle ou Femelle
Connector type - Pins Nb - Male or Female
Steckertyp - Stifte Nb - männlich oder weiblich

Connecteurs - Connectors - Anschlussstecker

AMP 1.5



D11868

AMP 1.5-7P-F

Connecteur AMP 1.5 simple femelle
Single female AMP 1.5 connector
Weiblich Anschlussstecker AMP 1.5

Pour / For / Für
LC5, LC7, LC8, LC9, LC12, LC11, LC10



NEW



D11809

AMP 1.5-7P-M

Connecteur AMP 1.5 simple mâle
Single male AMP 1.5 connector
Männlich Anschlussstecker AMP 1.5

HDSCS

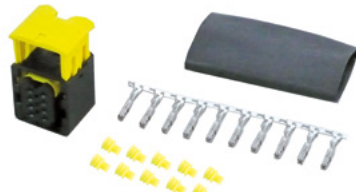

D13878

HDSCS-8P-F

Connecteur HDSCS simple
Single HDSCS connector
Anschlussstecker HDSCS

Pour / For / Für
LC8, LC11



AMP MCP



NEW



D14984

AMP-MCP-4P-F

Connecteur AMP MCP simple
Single AMP MCP connector
Anschlussstecker AMP MCP

Pour / For / Für
LCR19



JPT



D13876

JPT-2P-F

Connecteur JPT 2 voies
2 poles JPT connector
Anschlussstecker 2 polig JPT

Pour / For / Für
EPP98, SMD98,
FPL93, FE98



D13877

JPT-3P-F

Connecteur JPT 3 voies
3 poles JPT connector
Anschlussstecker 3 polig JPT

Pour / For / Für
ICDL94



SUPERSEAL



D13880

SS-2P-F

Connecteur SUPERSEAL 2 voies femelle
2 poles female SUPERSEAL connector
Weiblich Anschlussstecker 2 polig

Pour / For / Für
SMD98, FPL93, LC12, ICDL10,
LPL18



D14208

SS-2P-M

Connecteur SUPERSEAL 2 voies mâle
2 poles male SUPERSEAL connector
Männlich Anschlussstecker 2 polig



D14362

SS-3P-F

Connecteur SUPERSEAL 3 voies femelle
3 poles female SUPERSEAL connector
Weiblich Anschlussstecker 3 polig

Pour / For / Für
SMCU



D14331

SS-3P-M

Connecteur SUPERSEAL 3 voies mâle
3 poles male SUPERSEAL connector
Männlich Anschlussstecker 3 polig

POS



D13879

POS-2P-F

Connecteur 2 voies position femelle
2 pin female connector
Weiblich Anschlussstecker 2 polig

Pour / For / Für
LC8T, DX



D14214

POS-2P-M

Connecteur 2 voies position mâle
2 poles male connector
Männlich Anschlussstecker 2 polig



D14170

DT-2P-F

connecteur 2 voies DT femelle
2 poles female DT connector
Weiblich Anschlussstecker 3 polig DT

Pour / For / Für
feux de travail, work lights,
Arbeitsscheinwerfer



NEW



D15155

DT-2P-M

connecteur 2 voies DT mâle
2 poles male DT connector
Männlich Anschlussstecker 3 polig DT

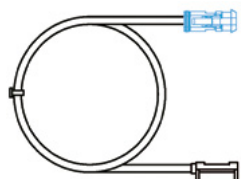

R12486

1500 mm

câble adaptateur DT 2V-CLICK-IN
adapter cable DT 2V-CLICK-IN
Adapterkabel DT 2V-CLICK-IN

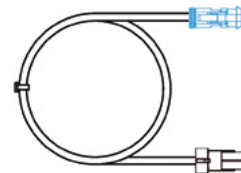

R14413

1500 mm

câble adaptateur DT-SUPERSEAL
adapter cable DT-SUPERSEAL
Adapterkabel DT-SUPERSEAL



D14436

DT06-4S-4P-F

connecteur 4 voies DT06-4S femelle
4 poles DT06-4S femaleconnector
Weiblich Anschlussstecker 4 polig DT06-4S

Pour / For / Für
CTL15, BL15



D14434

DT04-4P-M

connecteur 4 voies DT04-4P mâle
4 poles DT04-4P male connector
Männlich Anschlussstecker 4 polig DT04-4P



D14437

DTM06-4S-4P-F

connecteur 4 voies DTM06-4S femelle
4 poles DTM06-4S femaleconnector
Weiblich Anschlussstecker 4 polig DTM06-4S

Pour / For / Für
CTL15, BL15



D14435

DTM04-4P-M

connecteur 4 voies DTM04-4P mâle
4 poles DTM04-4P male connector
Männlich Anschlussstecker 4 polig DTM04-4P



D14352

DT-6P-M

connecteur 6 voies DT
6 poles DT connector
Anschlussstecker 6 polig DT

Pour / For / Für
CHL



Faisceaux Harnesses Kabelsatz

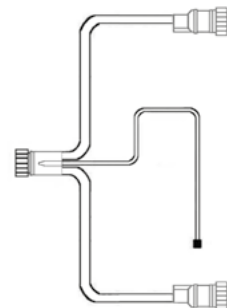
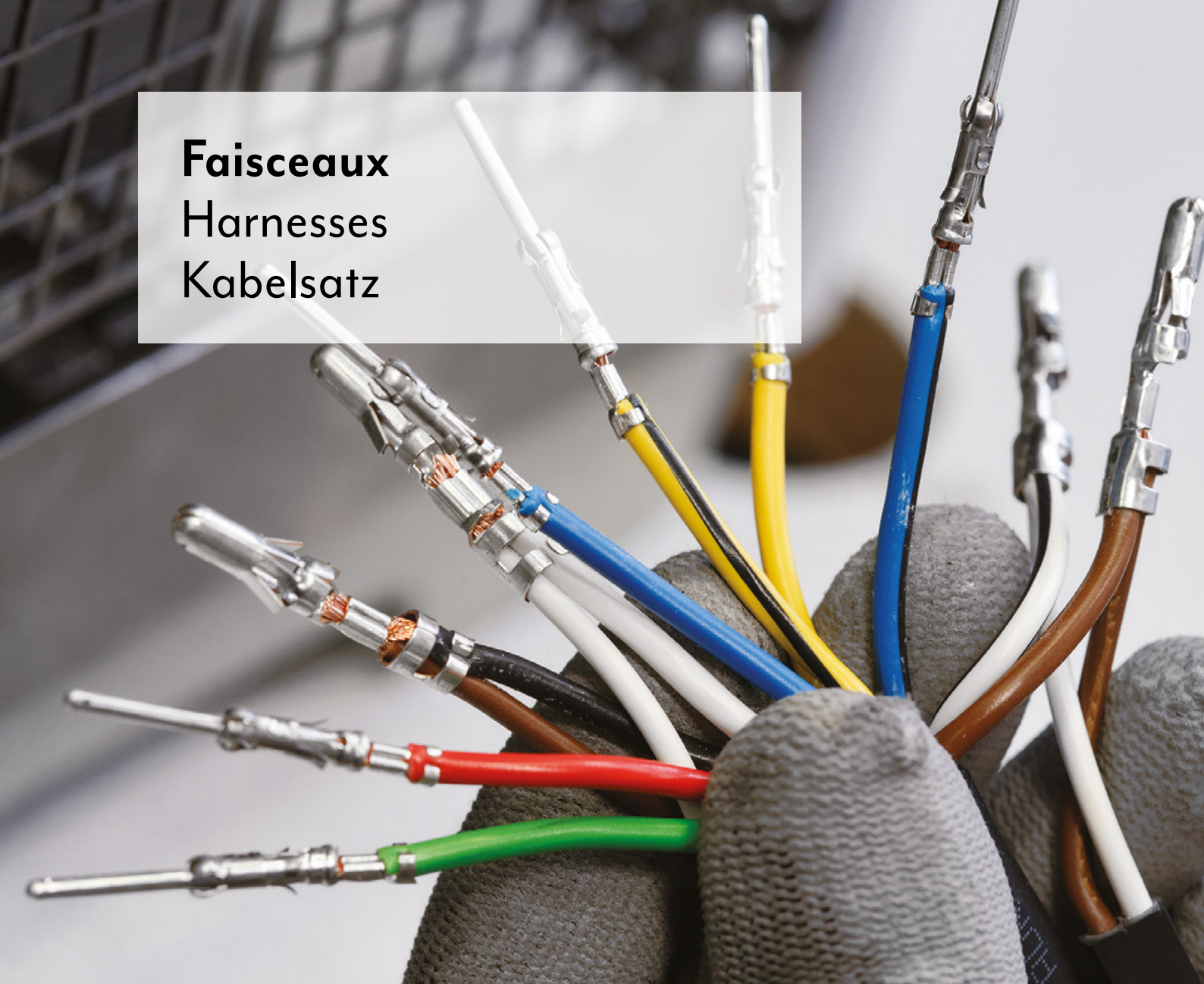

Flashez le QR code pour plus d'infos
Scan the QR code for more info
Scannen Sie den QR-Code für weitere Informationen

AMP 1.5-7P-M

Type connecteur - Nb pins - Mâle ou Femelle
Connector type - Pins Nb - Male or Female
Steckertyp - Stifte Nb - männlich oder weiblich

ADP RSC



ADR



24N 24S / 15P

ADAPTATEURS AVANT - FRONT ADAPTERS - ANSCHLUSSKABEL

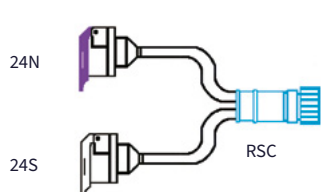

D10504 1000 mm 16V

D13257 1500 mm 15V

Faisceau prises 24N / 24S
Cable with plugs 24N / 24S
Anschlusskabel mit Steckdosen 24N / 24S

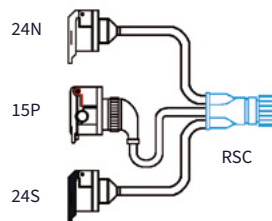

D14780 500 mm 16V

D13256 300 mm 15V

Faisceau prises 15P / 24N / 24S
Cable with plugs 15P / 24N / 24S
Anschlusskabel mit Steckdosen 15P / 24N / 24S

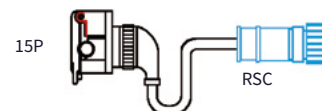

D13254 1000 mm 16V

D13255 600 mm 15V

Faisceau prises 15P
Cable with plugs 15P
Anschlusskabel mit Steckdosen 15P

*Comment différencier rapidement les connecteurs RSC ?
How to differentiate quickly the RSC connectors?
Wie unterscheiden sich die verschiedenen RSC-Stecker ?*

Un connecteur RSC 16 voies présente 4 pins centraux alors qu'un connecteur RSC 15 voies en présente 3 (voir schéma ci-contre).

A 16 pins RSC connector has 4 central pins while a 15 pins connector has 3 (see opposite draw).

Ein 16-poliger RSC-Stecker hat 4 zentrale Kontaktstifte, ein 15-poliger RSC-Stecker nur 3 (siehe nebenstehende Skizze).

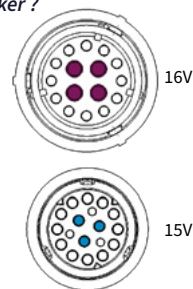

PRL RSC



ADR

CÂBLE D'ALIMENTATION PRINCIPALE - MAIN SUPPLY CABLE - HAUPTKABEL



D10505 16 m 16V

D13263 15 m 15V

Prolongateur RSC simple
Single RSC Main supply cable
Haupt-Verlängerungskabel für RSC

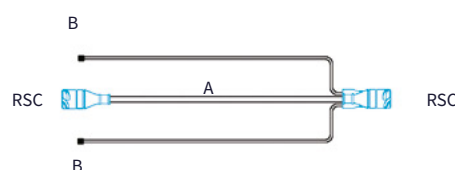

D10510 A: 10 m / B: 10 m 16V

D10508 A: 16 m / B: 16 m 16V

D13260 A: 15 m / B: 0,27 m* 15V

Prolongateur avec câbles plats
Main supply cable with flat cables
Haupt-Verlängerungskabel mit eingegossenem Flachkabel
* avec autoporants / with click-in / mit click-in

FCA RSC



ADR

ADAPTATEURS ARRIÈRE - REAR ADAPTERS - ANSCHLUSSKABEL

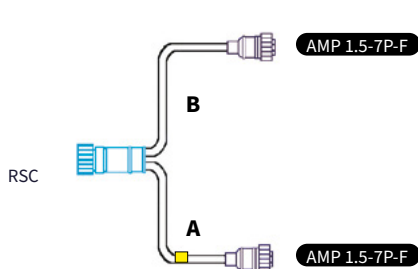

D10513 A: 3,5 m / B: 3,5 m 16V

Faisceau pour feux arrière avec surmoulages droits
Rear lamp cable with straight overmoulding
Leitungssatz für Heckleuchten mit geradem Anschlussstecker
■ = gauche - left - links

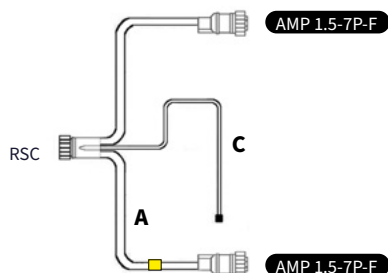

D13262 A: 2,5 m / B: 1,5 m / C: 1,2 m 15V

Faisceau pour feux arrière avec câbles plats et surmoulages droits
Rear lamp cable with flat cables and straight overmoulding
Leitungssatz für Heckleuchten mit geradem Anschlussstecker und Flachkabel für
■ = gauche - left - links

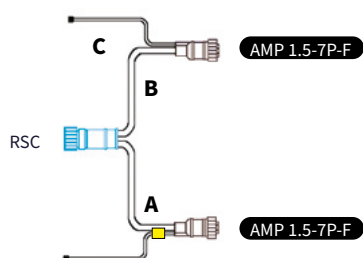

D10514 A/B: 2 m / C: 0,5 m 16V

D10515 A: 1,5 m / B: 2,5 m / C: 16 m 16V

R12499 A: 2,5 m / B: 1,5 m / C: 0,5 m 15V

Faisceau pour feux arrière avec câbles plats et surmoulages droits
Rear lamp cable with flat cables and straight overmoulding
Leitungssatz für Heckleuchten mit Flachkabel und geradem Anschlussstecker
■ = gauche - left - links

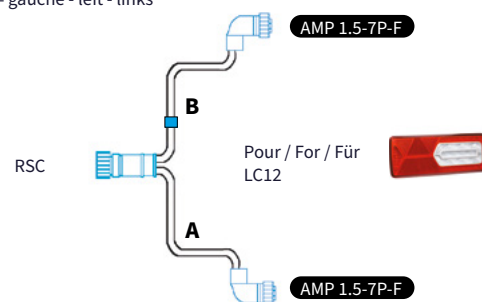

R14407 A: 2 m / B: 2 m 16V

Faisceau pour feux arrière LC12T avec surmoulages coulés
LC12T Rear lamp cable with 90° overmoulding
Leitungssatz für LC12T Heckleuchten mit 90° gewinkelter Stecker
■ = gauche - left - links

MDJ



ADR

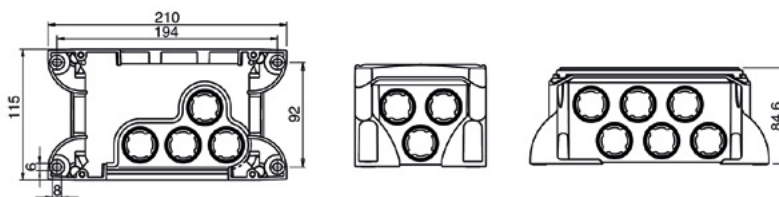

SYSTÈME MDJ - BOX SYSTEM - VERTEILERDOSE



175020



D11889



175086 cable Ø 5,9-6,9

177136 cable Ø 8,3-10

175096 cable Ø 11-12

Faisceaux - Harnesses - Kabelsatz

FCA

Pour feux arrière type LCR19 p.114

For rear lamps LCR19 p.114

Für Heckleuchten vom Typ LCR19 p.114



D14984

AMP-MCP-4P-F

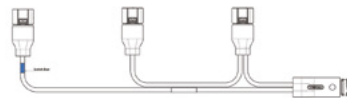

D14980

AMP 1.5-7P-M



D14983

AMP-MCP-4P-F

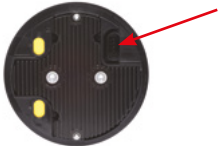

Affectations constructeurs
OE applications
Fahrzeugverwendung

SCHMITZ p. 93



D14846

HDSCS-6P-F

gauche - left - links



D14847

HDSCS-6P-F

droit - right - rechts

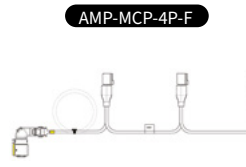

D14884

HDSCS-6P-F

gauche - left - links

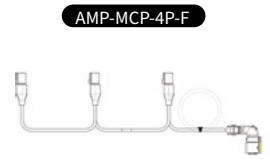

D14885

HDSCS-6P-F

droit - right - rechts

COVER



CAPOT DE PROTECTION - PROTECTIVE COVER - SCHUTZKAPPE

175 mm x 68 mm x 52 mm



D14721

Capot de protection pour connectiques LC12
Protective cover for LC12 rear lamp
Schutzkappe für Heckleuchte LC12

195 mm x 70 mm x 113 mm



D13726

Capot de protection pour connectique
coudée feu arrière
Protective cover for rear lamp 90° connector
Schutzkappe für Heckleuchte mit gewin-
keltem Stecker

195 mm x 70 mm x 113 mm



D13725

Capot de protection pour connectique
droite feu arrière
Protective cover for rear lamp straight
connector
Schutzkappe für Heckleuchte mit geradem
Stecker

KIT



KITS DE RÉPARATION POUR FEUX ARRIÈRE - REAR LAMPS REPAIR KITS - REPARATURSATZ FÜR HECKLEUCHTEN



D11868

AMP 1.5-7P-F

Connecteur AMP 1.5 simple
Single AMP 1.5 connector
Anschlussstecker AMP 1.5



D11865

500 mm

Connecteur AMP 1.5 avec câble plat
AMP 1.5 connector with flat cable
Anschlussstecker AMP 1.5 mit Flachkabel

NEW



D11809

AMP 1.5-7P-M

Connecteur AMP 1.5 simple mâle
Single male AMP 1.5 connector
Männlich Anschlussstecker AMP 1.5



ADR



AMP 1.5

Pour feux arrière type LC5, LC6, LC7, LC8, LC9, LC12 p.112

For rear lamps LC5, LC6, LC7, LC8, LC9, LC12 p.112

Für Heckleuchten vom Typ LC5, LC6, LC7, LC8, LC9, LC12 p.112



CÂBLES FEUX ARRIÈRE - REAR LAMP CABLES - ANSCHLUSSKABEL HECKLEUCHTEN



AMP 1.5-7P-F

D11626 2500 mm

D11627 4300 mm

Pour module de jonction 175020
For junction box 175020
Für Verteilerdose 175020



AMP 1.5-7P-F

D11628 2500 mm

Fils nus
Naked cable extremity
Kabellitze

AMP 1.5

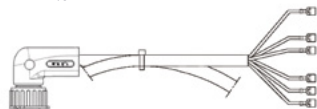

AMP 1.5-7P-F

280049 4000 mm

Fils nus
Naked cable extremity
Kabellitze

RALLONGES - EXTENSION LEADS - VERLÄNGERUNGSSCHNUR



AMP 1.5-7P-M

AMP 1.5-7P-F

D12449 1000 mm

D12450 2000 mm

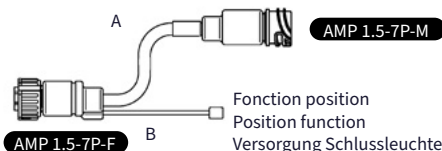

AMP 1.5-7P-M

AMP 1.5-7P-F

R12575 A: 3 m / B: 3 m

R12576* A: 0,5 m / B: 3 m

* Pour / For / Für LC9 p. 135



DOUBLEUR DE FEUX - DOUBLE REAR LAMP CABLE - KABEL FÜR ZWEI RÜCKLEUCHTEN



AMP 1.5-7P-F

AMP 1.5-7P-M

D11689 500 mm





ADR



AMP JPT

Pour éclairateurs de plaque EPP98 p. 152 et feux de position SMD98, FE98 et FPL93 p. 161

For number plate lamp EPP98 p. 152 and position lamp SMD98, FE98 and FPL93 p. 161

Für Kennzeichenleuchte EPP98 S.p. 152 und Markierungsleuchten SMD98, FE98 und FPL93 S.p. 161



CÂBLES FEUX LATÉRAUX - SIDE MARKER LAMP CABLES - KABEL FÜR POSITIONSLEUCHTEN AMP JPT



JPT-2P-F

280009	A : 2 m
280019	A : 4 m
280029	A : 6 m

Fils nus
Naked cable extremity
Kabellitze

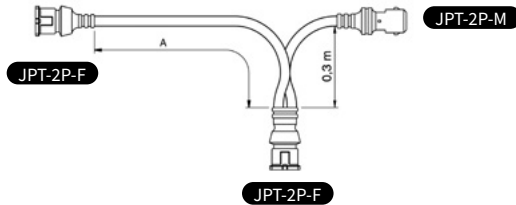

280059	A : 3,5 m
---------------	-----------

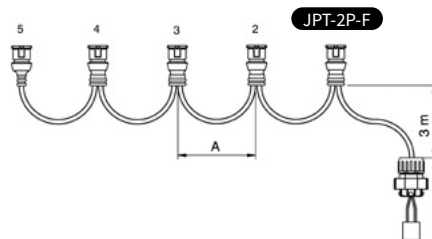

Pour / For / Für
MDJ 175020

4 x JPT	280099	A : 3,5 m	280139	A : 5,5 m
5 x JPT	280109	A : 3,5 m	280149	A : 5,5 m

KIT

KITS DE RÉPARATION POUR FEUX LATÉRAUX - SIDE MARKER LAMPS REPAIR KITS REPARATURSATZ FÜR POSITIONSLEUCHTEN

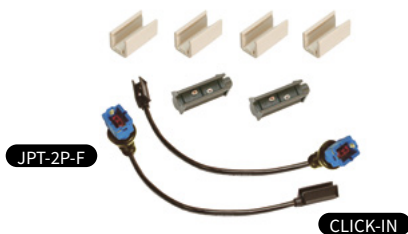

001796	500 mm
001806	1500 mm



001786	500 mm
---------------	--------



D13876	JPT-2P-F
---------------	----------

Connecteur JPT 2 voies
2 poles JPT connector
Anschlussstecker 2 polig JPT

FCA



ADR



SUPERSEAL

CÂBLES FEUX LATÉRAUX - SIDE MARKER LAMP CABLES - KABEL FÜR POSITIONSLEUCHTEN SUPERSEAL

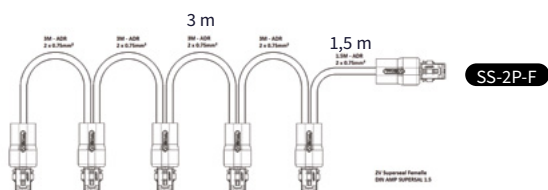

R14173 17,5 m

Pour éclairateurs de plaque LPL18, EPP96LED p. 150 et feux de position SMD98, DX p. 166

For number plate lamp LPL18, EPP96LED p. 150 and position lamp SMD98, DX p. 166

Für Kennzeichenleuchte LPL18, EPP96LED p. 150 und Markierungsleuchten SMD98, DX S.p. 166

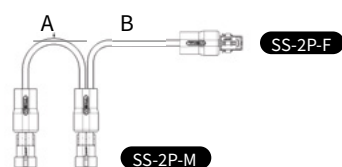

R14418 A : 300 mm/ B:500 mm



R14426 1500 mm

Rallonge SUPERSEAL 2 voies
2 poles SUPERSEAL extension lead
Verlängerungsschnur Anschlussstecker 2 polig



D14985 1500 mm



KIT



KITS DE RÉPARATION POUR FEUX LATÉRAUX - SIDE MARKER LAMPS REPAIR KITS REPARATURSATZ FÜR POSITIONSLEUCHTEN



D13880

SS-2P-F

Connecteur SUPERSEAL 2 voies femelle
2 poles female SUPERSEAL connector
Weiblich Anschlussstecker 2 polig

Pour / For / Für
SMD98, FPL93, LC12, ICDL10,
LPL18



D14208

SS-2P-M

Connecteur SUPERSEAL 2 voies mâle
2 poles male SUPERSEAL connector
Männlich Anschlussstecker 2 polig



Câble plat
Flat cable
Flachkabel



D11268 16 m

A10779 100 m

Câble plat - Flat cable - Flachkabel



POS-2P-F

D11147 500 mm

Câble plat optionnel avec connecteur 2 voies pour repiquage sur feu arrière LC8
Optional flat cable with 2-pin connector to plug-in LC8 rear lamp
Flachkabel mit 2-polig Anschlussstecker zum direkten Anschluss an die Heckleuchte LC8

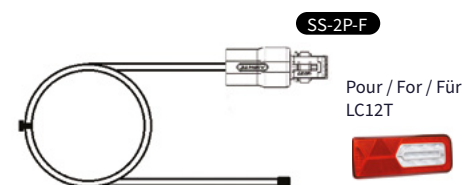

SS-2P-F

Pour / For / Für LC12T

R14412 16 m

Câble plat optionnel avec connecteur 2 voies SUPERSEAL pour repiquage sur feu arrière LC12T
Optional flat cable with SUPERSEAL 2-pin connector to plug-in LC12T rear lamp
Flachkabel mit SUPERSEAL 2-polig Anschlussstecker zum direkten Anschluss an die Heckleuchte LC12T

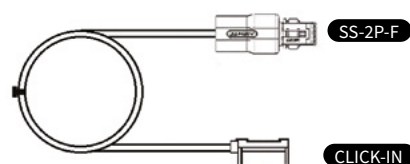

SS-2P-F

CLICK-IN

R14416 1500 mm

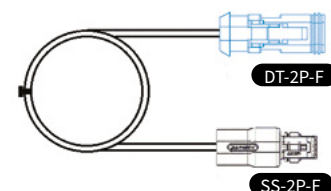

DT-2P-F

SS-2P-F

R14413 1500 mm



Pour / For / Für CTL15

R14339 7,5 m

4V DT



Pour / For / Für BL15

R14338 8,5 m

4V DT



CLICK-IN

D10517 500 mm

D10518 1500 mm

D10519 3500 mm

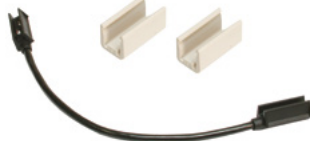

CLICK-IN

D10132 200 mm



151236

Verrou pour click-in à usage unique
Clamp for click-in, single use
Einmal click-in Riegel



001826

Obtuteur seal-in
Seal-in obturator
Verschlusshülse seal-in

Systemes câblage et feux

Wiring and lamps systems

Verkabelung und Leuchten Systeme

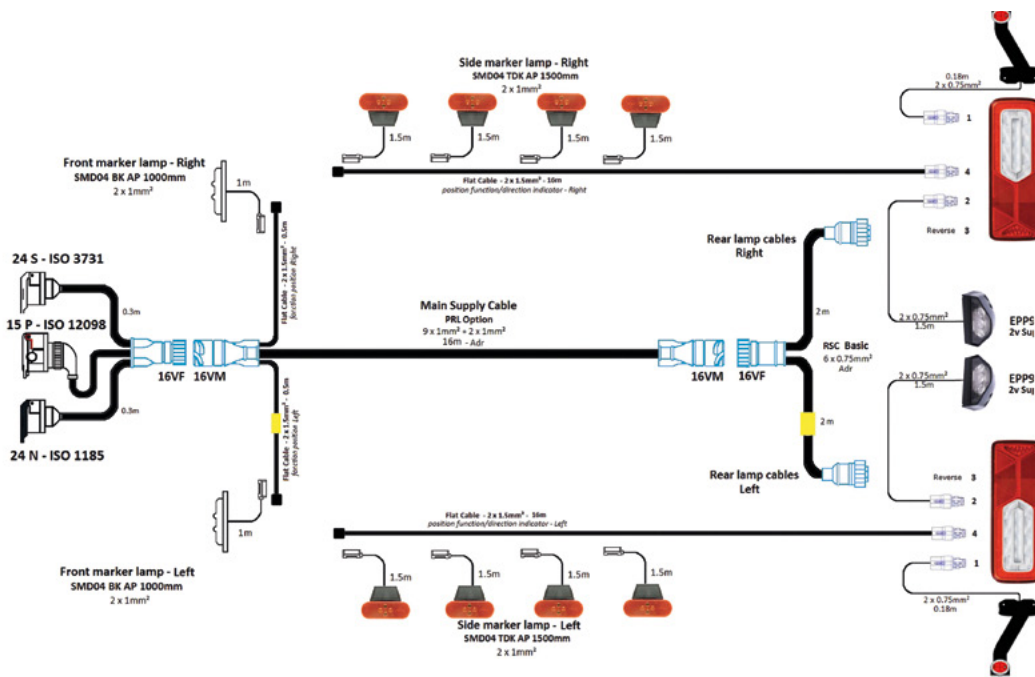
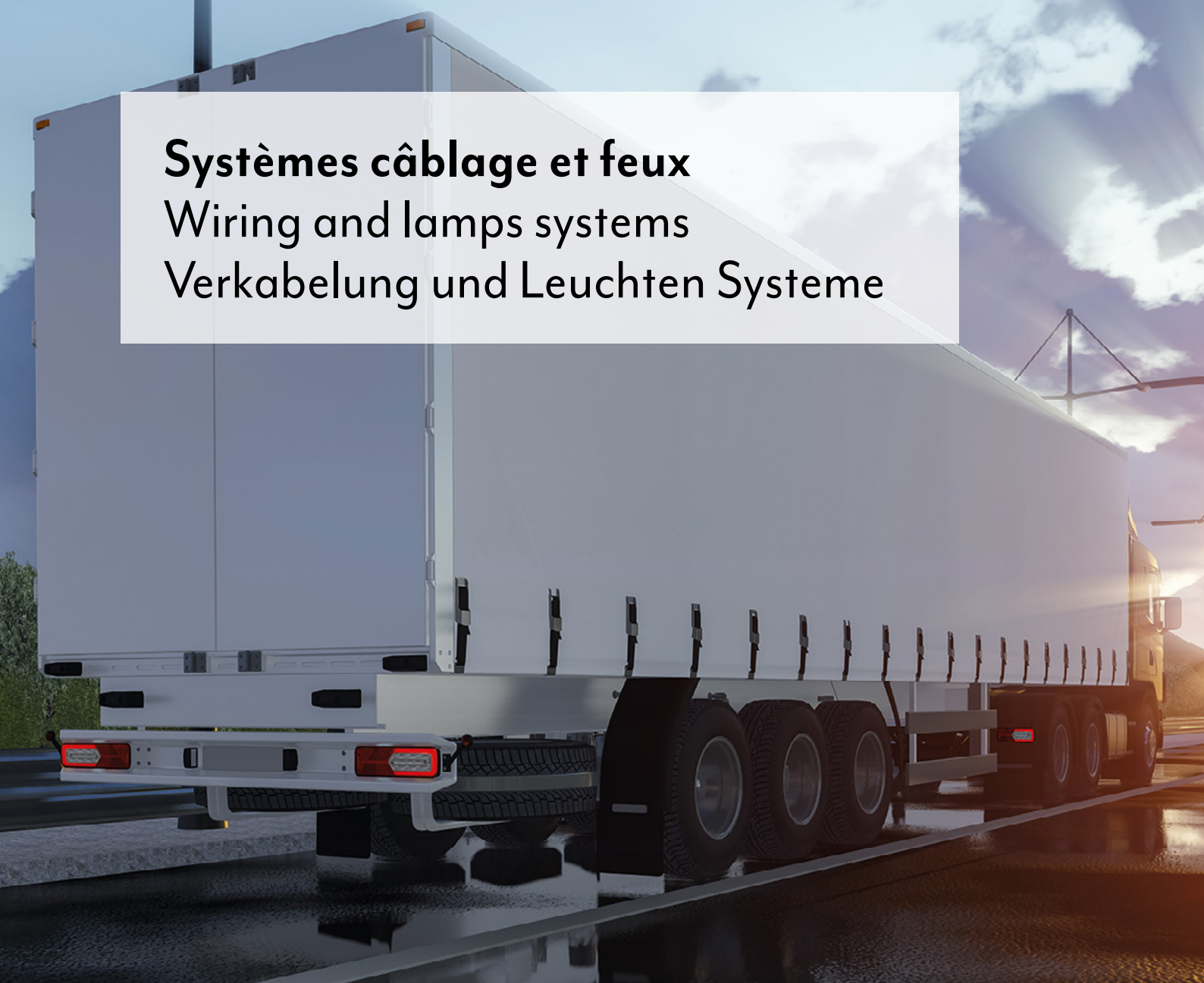

Flashez le QR code pour plus d'infos
Scan the QR code for more info
Scannen Sie den QR-Code für weitere Informationen

AMP 1.5-7P-M

Type connecteur - Nb pins - Mâle ou Femelle
Connector type - Pins Nb - Male or Female
Steckertyp - Stifte Nb - männlich oder weiblich

KITS COMPLETS LED - LED COMPLETE KITS - LED GESAMT-KIT



FEUX DE POSITION LATÉRAUX LED CLIGNOTANTS gestion selon supplément 6 - R48
 LED SIDE MARKER FLASHING LAMPS management supp 6 - R48
 LED SEITLICHEN BLINKLEUCHTENT Ansteuerung gemäß der Erweiterung 6 - R48



24V

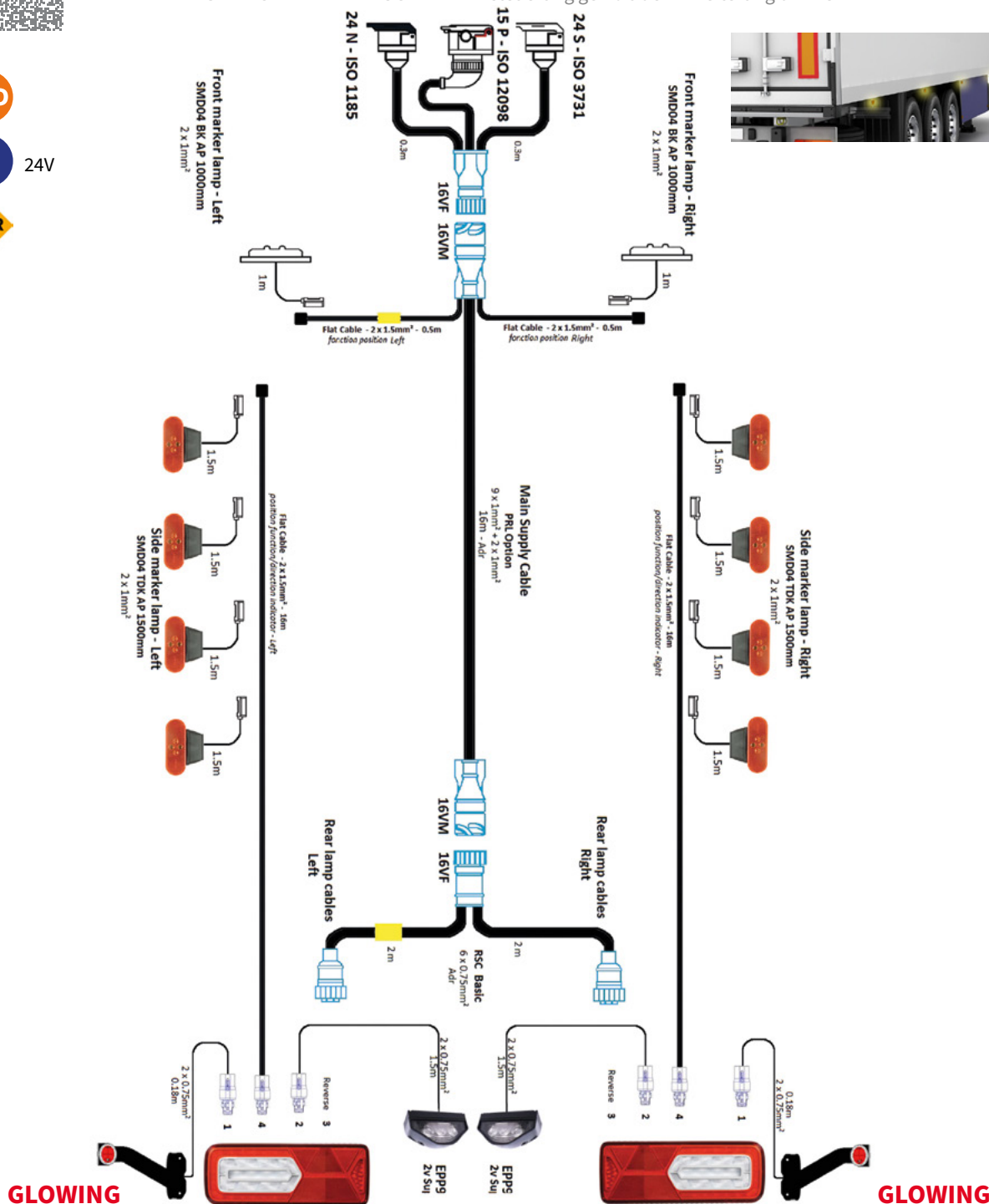

A14366

Kit complet 100% LED : 2 feux arrière LC12TLED, 2 feux sur antennes DX led câbles SS 1,5 m, 2 Eclairers de plaque EPP96 LED câble ADR SS 1,5 m, 8 feux de position latéraux clignotants LED SMD04 câble AP 1500 mm, 2 feux de position avant LED SMD04 câble AP 1000 mm.

Câblage système RSC de 16 m avec câbles plats latéraux de 16 m connectique SS, câble adaptateur arrière de 2 m, adaptateur avant 3 prises.

Complete kit 100% LED: 2 rear lamps LC12TLED, 2 LED end outline marker lamps DX cable SS 1,5 m, 2 license plate lamps EPP96 LED ADR cable SS 1,5 m, 8 LED flashing side marker lamps SMD04 click-in cable 1500 mm, 2 LED front marker lamp SMD04 click-in cable 1000 mm.

RSC system wiring of 16 m with 16 m side flat cables SS connector, 2 m rear adapter, front adapters 3 plugs.

Komplettkit 100% LED: 2 Rückleuchten LC12TLED, 2 Spuralleuchteuchten DX LED mit 1,5 m Kabel und SS Anschluss, 2 LED Kennzeichenleuchten mit 1,5 m Kabel und SS Anschluss, 8 LED Seitlichen Blinkleuchtent SMD04, 1500mm Kabel und Click-in Anschluss, 2 vordere LED Positionsleuchten SMD04 mit 1000mm Kabel und Click-in Anschluss.

16m RSC Hauptkabel und 2 seitliche 16m lange Flachbandkabel mit SS Anschluss, hinteres 2m langes Verteilerkabel, vorderes Anschlusskabel mit 3 Steckdosen.

KITS COMPLETS LED - LED COMPLETE KITS - LED GESAMT-KIT



24V

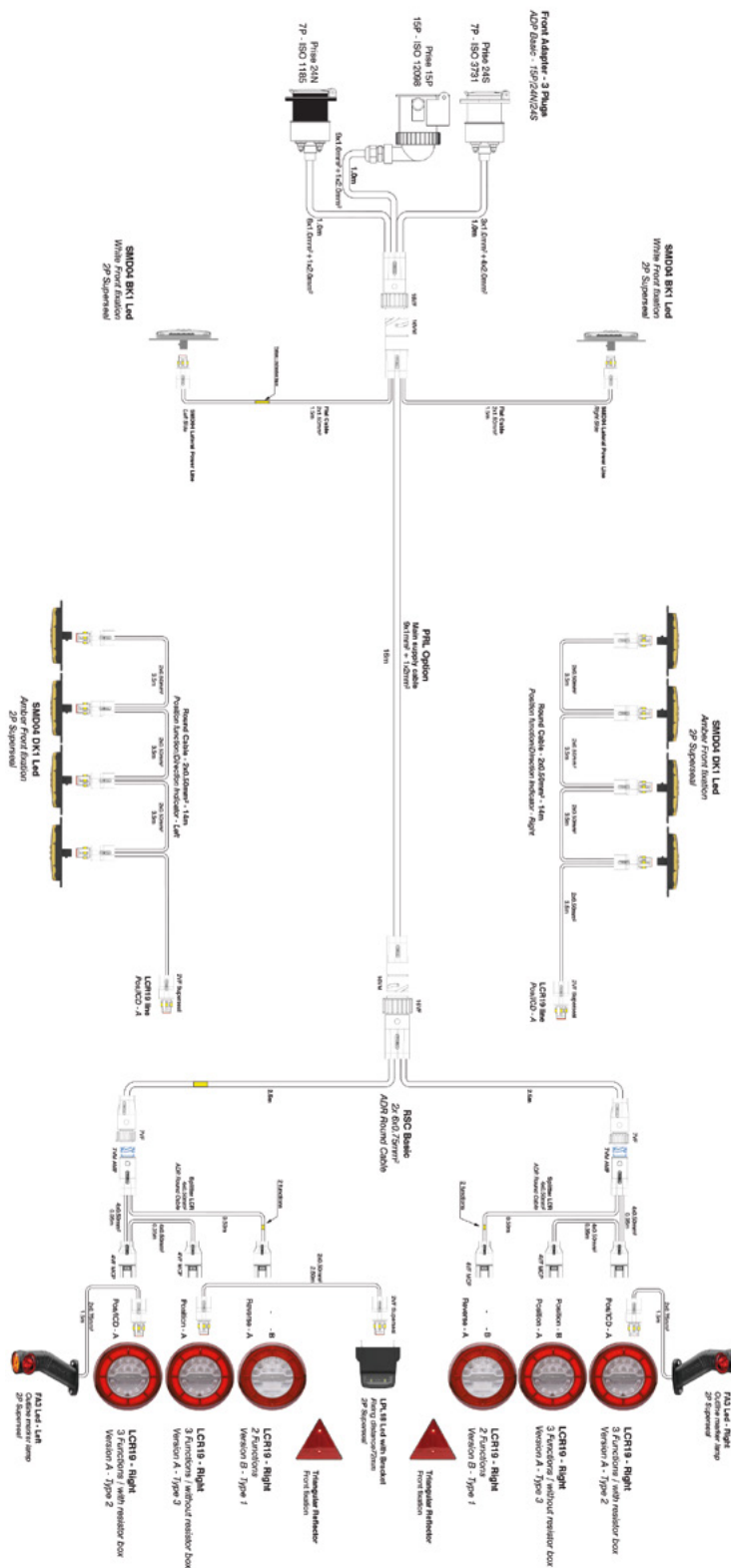

NEW

A15153

Kit complet 100% LED : 2 feux arrière LCR19 3 fonctions avec résistance, 2 feux arrière LCR19 3 fonctions sans résistance, 2 feux arrière LCR19 2 fonctions, 2 feux sur antennes FA3 led câbles SS 1,5 m, 1 Eclaireur de plaque LPL18 câble ADR SS 2,5 m, 8 feux de position latéraux clignotants LED SMD04 SS, 2 feux de position avant LED SMD04 SS. Câblage système RSC de 16 m avec câbles plats latéraux de 16 m connectique SS, câble adaptateur arrière de 2,5 m, adaptateur avant 3 prises.

Complete kit 100% LED: 2 rear lamps LCR19 3 functions with resistor box, 2 rear lamps LCR19 3 functions without resistor box, 2 rear lamps LCR19 2 functions, 2 LED end outline marker lamps FA3 cable SS 1,5 m, 1 license plate lamp LPL18 ADR cable SS 2,5 m, 8 LED flashing side marker lamps SMD04 SS, 2 LED front marker lamp SMD04 SS. RSC system wiring of 16 m with 16 m side flat cables SS connector, 2,5 m rear adapter, front adapters 3 plugs.

Komplettkit 100% LED: 2 Heckleuchten LCR19 3 Funktionen mit Widerstandsbox, 2 Heckleuchten LCR19 3 Funktionen ohne Widerstandsbox, 2 Heckleuchten LCR19 2 Funktionen, 2 Spurhalteleuchten FA3 LED mit 1,5 m Kabel und SS Anschluss, 1 LED Kennzeichenleuchte mit 2,5 m Kabel und SS Anschluss, 8 LED Seitlichen Blinkleuchte SMD04, SS Anschluss, 2 vordere LED Positionleuchten SMD04 mit SS Anschluss. 16m RSC Hauptkabel und 2 seitliche 16m lange Flachbandkabel mit SS Anschluss, hinteres 2,5 m langes Verteilerkabel, vorderes Anschlusskabel mit 3 Steckdosen.

Index : Liste de correspondance - Cross-list - Hersteller-Nr.

	OES	VIGNAL		OES	VIGNAL
DAF	0867930	196010	IVECO	500356783	D11482
	1272653	067500		504097923	193290
	1284211	167640		580224029	160120
	1284212	167630		5801363428	169390
	1304788	168010		5801363430	169400
	1304789	168020		5801363431	169410
	1329718	193020		5801363432	169420
	1401713	152170		5801426889	153220
	1401731	152180		5801426894	153210
	1403887	195010		5801426912	153200
	1451482	052500		5801426917	153230
	1519368	D12953		5801426975	153240
	1608352	001726		5801426977	153250
	1625985	169160		5801426979	153260
	1625986	169170		5801572018	110560
	1626101	119550		5801572024	110550
	1626102	001616		5801631615	198760
	1653605	193200		5801637182	155480
	1660967	168890		5801637199	155450
	1660968	169380		5801637201	155460
	1846491	117000		5801637202	155470
	1846492	117010		5801757326	155500
	1875576	155110		5801757328	155490
	1875577	155100		5802000568	160080
	1875578	155120		5802000570	160110
	1875579	155140		5802000573	160100
	1875580	155130		5802000767	160090
	1875581	155150		5802000770	160130
	1914690	055020		5802000772	160120
	1914691	055030		5802055272	155540
	1973239	001830		5802055273	160140
	1626319/1284213	168100		5802062689	160150
	1626320/1284214	168390		5802240291	160150
	1814096/1815754	109010		5802240292	160080
				5802240293	160110
FIAT	1305797	193170		5802240294	160140
	71749250	193360		5802240295	160100
	1356794080	193360		5802240296	160090
	1372698080	153280		5802240297	160130
	1372699080	153270		5802830033 EZ	154200
				5802830034 EZ	154210
FORD	1940131	D16109		5802980630 EZ	154220
	1940132	D16108		5802980631 EZ	154220
				5802984152 EZ	053730
IVECO	791123	152180		A610067-002	052500
	1608352	001726		R504083205	168480
	41200664	193170	LECAPITAINE	661012	D11689
	41221040	119930		661058	164050
	41221041	119920			
	42535711	052500	MAN	7CE945095	155550
	42555041	110530		7CE945096	155560
	42555042	110520		81.25225-6544	156200
	42555131	D12337		81.25225-6545	156210
	42555132	D12336		81.25225-6547	156220
	42566495	052500		81.25229-6059	056500
	47363002	199000		81.25229-6060	056510
	69500026	D12335		81.25207-6074	212020
	69500032	D12334		81.25207-6075	212030
	69500044	D12341		81.25103-6076	D16110
	69500047	D12340		81.25225-6526	169180
	69500590	D12339		81.25225-6523	169170
	69500591	D12338		81.25225-6524	169160
	93161844	067500		81.25225-6530	169190
	99463244	168610		81.25225-6033/6464	168090
	500308514	193020		81.25225-6034	168100
	500356782	D11481			

Index : Liste de correspondance - Cross-list - Hersteller-Nr.

	OES	VIGNAL		OES	VIGNAL
MAN	81.25225-6528	168490	RENAULT TRUCKS	5001846846	152050
	81.25229-6051	067500		5001846847	152020
MERCEDES	A 000 826 20 56	056540	5001846848	152030	
	A 000 826 21 56	056550	5001846849	152060	
	A 405 820 0158	212420	5001846850	152070	
	A 906 820 04 64	156340	5001847153	052500	
	A 906 820 17 64	156350	5001847582	169060	
	A 910 206 29 00	212010	5001847583	169070	
	A 910 820 64 00	160400	5001847584	169000	
	A 910 820 65 00	160410	5001847585	169010	
	A 910 826 10 00	060000	5001847586	169020	
	A 910 826 11 00	060010	5001847587	169030	
	A 910 906 36 00	212010	5001847588	067500	
	A 910 906 69 00	212420	5001847589	001726	
	A 910 906 6900	212420	5001847597	119470	
	A 949 540 01 04	196170	5001857964	152510	
	A 956 544 00 11	1987860	5001857965	152520	
	A 956 820 00 59	116200	5001858092	152500	
	A 956 820 02 58	212710	5001858093	152600	
	A 959 544 01 03	155590	5001862030	102200	
	A 959 544 02 03	155600	5001862030	193200	
	A 959 544 03 03	155610	5001864535	169310	
A 960 820 0258	212710	5001864536	169320		
A 960 820 0358	212710	5001870556	152180		
NISSAN	26164-9X402	119550	5010217022	185020	
	26244-9X400	001616	5010217023	185040	
	26554-9X126	052500	5010271807	185160	
	26555-9X125	152180	5010293829	196010	
	26555-9X126	152170	5010306792	193020	
	26555-9X128	153120	5010392231	052000	
			5010595381	152170	
OPEL	4421269	196010	5010595382	152180	
	4421265/6	152180	7420802348	159010	
PEUGEOT CITROËN	9815126980	153280	7420802350	159020	
	9815127080	153270	7420802353	159030	
	63501FS	153280	7420802418	059000	
	6350FS	153270	7420862032	152880	
RENAULT TRUCKS	23811106	212740	7420862035	152880	
	23811107	212750	7420862038	152190	
	5000296591	166000	7420862041	152200	
	5000296591	166100	7420894265	193280	
	5000296592	167000	7421106206	198650	
	5000296592	167100	7421137718	104450	
	5000296593	066000	7421268609	191170	
	5000296594	067000	7421396991	D13019	
	5000296718	088010	7421430181	104570	
	5000461058	181000	7422800385	158030	
	5000461059	181050	7422800386	158040	
	5000623050	188310	7422800391	058000	
	5000807304	040000	7423080010	158050	
	5000808166	040500	7423292490	059500	
	5000808171	141000	7423374865	D10596	
	5000808172	141500	7423398397	123020	
	5001831194	168220	7423398399	123000	
	5001832999	168260	7423398400	123010	
	5001834561	195010	7423398635	113100	
	5001834565	119450	7423467438	159520	
5001834568	001616	7423530438	159520		
5001835853	168140	7423530440	159500		
5001846843	152000	7423530441	159510		
5001846844	152010	7423530442	159530		
5001846845	152040	7425982261	158030		
		7482252291	115040		
		7482252506	115000		
		7482255014	115030		
		7482266219	113020		

Index : Liste de correspondance - Cross-list - Hersteller-Nr.

	OES	VIGNAL		OES	VIGNAL
RENAULT TRUCKS	7482285707	113030	VOLKSWAGEN	2E0 945 112 A	056550
	7482346591	115020		7CA 945 091	152180
	7482367030	115010		7CA 945 092	152180
	7482392733	198620		7CA945095	155570
	7482522006	104570		7CA945096	155580
	7482586940	198740			
	7484185589	D14161	VOLVO TRUCKS	20537280	052000
	7484538758	193020		20717520	102200
	7484585204	158040		20721495	196010
	7484585206	158050		20734485	193020
	7484585208	158030		20745060	052500
	7485118470	152170		20745066	001726
	7700353021	196020		20745225	195010
	7700377130	D14590		20745227	001616
	7700377208	198510		20769775	159010
	8200602314	D14593		20769776	159020
	265100848R	196010		20769777	159030
	265500292R	152180		20769781	152880
	265504514R	152180		20769782	152880
	265550674R	152180		20769783	152190
	265551402R	152180		20769784	152200
				20789440	198620
SCANIA	1350343	067500		20802418	059000
	1365963	168350		20872890	D12111
	1365964	168360		21087346	207010
	1756751	156780		21087347	207020
	1756754	156770		21214524	114020
	1784669	056540		21214534	114000
	1784670	056550		21341202	119550
	1791369	156790		21346521	111020
	2020496	D10596		21346522	111030
	2021575	156780		21368779	116050
	2021576	156790		21368781	116060
	2021578	155020		21368782	116030
	2021579	156770		21368783	116020
	2129985	156770		21396991	D13019
	2129986	155020		21448885	107040
	2129987	156780		21478751	107050
	2129988	156790		21735299	159530
	2129991	056550		21735301	159520
	2129992	056540		23354972	158030
	2160127	155090		23354973	158040
	2160128	155080		23354974	158050
	2340796	155520		23522304	159520
	2862201	D14852		23522305	159530
				23522307	159500
				23522308	159510
SCHMITZ	1302341	161000		23690764	159520
	1302342	161010		23690765	159530
	1348566	D14488		23690769	159500
	1364736	161000		23742314	212730
	1364737	161010		24080598	113110
	1370066	161280		82114500	107010
	1370067	161290		82114502	107050
	1415545	213010		82114504	107040
	1415546	213090		82114506	107000
UD TRUCKS	84655961	120000		82116545	207000
	261319Z01B	153860		82150539	114010
	261319Z01C	153870		82151157	111000
	261319Z01D	153880		82151205	111010
	265109Z00A	196010		82202076	113000
	265509Z00A	052500		82278930	112010
				82278938	112000
VOLKSWAGEN	2E0 945 095 A	156340		82348508	116040
	2E0 945 096 A	156350		82349220	116010
	2E0 945 111 A	056540		82349221	116000

Index : Liste de correspondance - Cross-list - Hersteller-Nr.

	OES	VIGNAL
VOLVO TRUCKS	82355678	107000
	82355684	107010
	82467736	107500
	82467737	107510
	82483073	159510
	82483074	159500
	82849894	158030
	82849905	058000
	82849923	158050
	82849925	158040
	84044658	198740
	84122332	059500
	84139927	107000
	84139939	107010
	84185589	D14161
	84195505	158030
	84195519	158040
	84195521	158050
	84441759	159500
	84441760	159510
	84441766	158030
	84441767	158040
	84441768	158050
	84441936	159520
	84441937	159530
	84538758	193020
	85105029	001766
VOLVO BUS	20480486	198650
	70364301	198640
VOLVO CONSTRUCTION	11170068	198520
	23374865	D10596

Index : Références - Part numbers - Artikelnummern

000086	158, 178	104180	170	116060	103	154220	41, 136
000176	152, 178	104210	165	116200	57	155020	91, 131
001616	107, 157	104220	165	117000	22, 156	155080	91, 131
001619	154, 156	104250	165	117010	22, 156	155090	91, 131
001696	161, 166, 168, 171	104260	165	119450	157	155100	20, 126
001716	161, 166, 168, 171	104290	160	119470	157	155110	20, 126
001726	162, 168, 215	104300	160	119550	157	155120	20, 126
001766	104, 167	104310	160	119920	154	155130	20, 126
001786	268	104330	170	119930	154	155140	20, 126
001796	268	104340	170	120000	156	155150	20, 126
001806	268	104360	170	123000	65	155450	35, 128
001826	271	104450	160	123010	65	155460	35, 128
001830	242	104520	160	123020	65	155470	35, 128
001846	18	104570	160	141000	146	155480	35, 128
001872	129, 242	104640	165	141500	146	155490	35, 128
001916	168	104650	165	151236	271	155500	35, 128
002100	115	104670	165	152000	77, 81	155520	91, 131
014580	154	104680	170	152010	77	155540	35, 128
040000	146	104690	160	152020	73, 78, 82	155550	52, 129
040500	146	104700	165	152030	78	155560	52, 129
052000	137	104710	170	152040	77	155570	100, 127
052500	137, 138, 139	104720	160	152050	77	155580	100, 127
053700	140, 141	104760	165	152060	78	155590	55
053710	140, 141	104770	165	152070	78	155600	55
053730	136	104840	160	152130	137	155610	55
055020	126, 127	107000	102, 105, 155	152140	137	156040	133
055030	126, 127	107010	102, 105, 155	152150	137	156050	133
055040	128	107040	102, 105, 155	152160	137	156060	133
055050	128	107050	102, 105, 155	152170	137	156070	133
056000	130	107500	105, 155	152180	137	156130	133
056010	130	107510	105, 155	152190	137	156200	52, 129
056020	132	109010	21, 156	152200	137	156210	52, 129
056030	132	110520	154	152500	73, 82	156220	52, 129
056500	129, 130	110530	154	152510	73, 82	156250	27, 49, 134
056510	129, 130	110550	154	152520	73, 82	156260	27, 49, 134
056540	131, 132	110560	154	152600	81	156290	130
056550	131, 132	111000	101, 155	152880	77, 81, 107	156300	45, 130
056700	133	111010	101, 155	153000	140	156310	45, 130
056710	133	111020	101, 155	153010	140	156340	56, 100, 132
056720	134	111030	101, 155	153020	140	156350	56, 100, 132
056730	134	112000	102	153030	140	156380	49, 134
058000	118	112010	102	153040	140	156390	49, 134
059000	135	112110	177	153050	140	156540	18, 130
059500	119	112120	177	153060	140	156550	18, 130
060000	116, 117	112130	177	153070	140	156590	132
060010	116, 117	112710	177	153120	137	156600	132
066000	145	112720	177	153130	140	156630	133
067000	142	113000	104	153160	18	156640	133
067500	141, 142, 143, 144	113020	66	153170	18	156770	91, 131
067600	145	113030	66	153200	36, 139	156780	91, 131
067610	145	113100	65	153210	36, 139	156790	91, 131
080026	164	113110	104	153220	36, 139	158030	63, 101, 118
080046	164	114000	102	153230	36, 139	158040	63, 101, 118
087020	163	114010	102	153240	36, 139	158050	63, 101, 118
087030	172	114020	102	153250	36, 139	159010	64, 67, 71, 106, 135
087040	158, 169	115000	66	153260	36, 139	159020	64, 67, 71, 106, 135
088010	178	115010	66	153270	138	159030	64, 67, 71, 106, 135
094016	167	115020	66	153280	138	159500	64, 76, 105, 119
094036	161	115030	66	153660	141	159510	64, 76, 105, 119
094056	171	115040	66	153670	141	159520	64, 76, 105, 119
102200	162, 215	116000	103	153700	141	159530	64, 76, 105, 119
104090	113, 115, 165	116010	103	153710	141	160080	34, 116
104100	113, 115, 165	116020	103	153880	98	160090	34, 116
104130	160	116030	103	153890	98	160100	34, 116
104140	160	116040	103	154200	41, 136	160110	34, 116
104170	170	116050	103	154210	41, 136	160120	34, 116

Index : Références - Part numbers - Artikelnummern

160130	34, 116	168590	39, 42, 143	196010	152	280059	268
160140	34, 116	168600	38, 39, 40, 42, 143	196020	152	280099	268
160150	34, 116	168610	38, 39, 40, 143	196170	152	280109	268
160400	56, 117	168770	145	198510	166	280139	268
160410	56, 117	168780	145	198520	166	280149	268
161000	112	168790	145	198530	166	300000	47, 215
161010	112	168800	145	198540	166	300010	47, 215
161120	112	168810	144	198580	166	610080	177
161130	112	168830	145	198620	65, 104, 167	611010	177
161180	112	168890	21	198640	109, 171	611020	177
161190	112	169000	68, 72, 77	198650	75, 109, 166	611070	255
161200	112	169010	68, 72, 77	198660	161	611080	255
161210	112	169020	68, 72	198690	161	611110	255
161260	112	169030	68, 72	198740	65, 104, 167	611140	255
161270	112	169060	69, 73	198760	36, 166	611150	255
161280	112	169070	69, 73	198810	166	611500	254
161290	112	169160	21, 53, 142	199000	150	611510	254
161420	112	169170	21, 53, 142	199020	150	611520	254
161430	112	169180	53, 142	199030	150	611530	254
161460	112	169190	53, 142	199040	113, 115, 150	611540	254
161470	112	169310	67, 71	207000	103, 106	611550	254
161500	112	169320	67, 71	207010	103, 106	611560	257
161510	112	169380	21	207020	103, 106	611570	257
161560	112	169390	37, 143	211000	220	611580	254
161570	112	169400	37, 143	212010	56, 220	611590	254
161580	112	169410	37, 143	212020	52, 220	630100	241
161590	112	169420	37, 143	212030	52, 221	630110	241
161700	113	175020	265	212120	220	630120	241
161710	113	175086	265	212160	220	1987860	57
161720	113	175096	265	212170	221	A10060	256
161730	113	177136	265	212400	220	A10061	256
163010	122	180010	164	212420	26, 55, 56, 220	A10062	257
163050	122	180040	164	212460	220	A10064	256
164000	17, 120	181000	178	212470	221	A10065	257
164010	17, 48, 120	181050	158	212520	220	A10066	257
164020	97, 120	185020	69, 85	212560	220	A10779	270
164030	97, 120	185040	69	212570	221	A11212	274
164050	48	185160	69	212710	220	A14366	273
165020	17, 48, 120, 195	187120	163	212730	220	A14420	121
165030	17, 48, 120, 195	187130	172	212740	220	A15153	275
165040	31, 97, 120, 195	187140	158, 169	212750	221	D10132	271
165050	31, 97, 120, 195	187720	163	213010	14, 59, 93, 114	D10227	152
166000	145	187730	172	213070	51, 59, 114	D10493	166
166100	145	187760	158, 169	213090	14, 93, 114	D10494	166
167000	142	188010	178	213150	14, 51, 59, 114	D10495	166
167100	142	188110	178	213160	114	D10496	166
167500	142	188210	178	213200	114	D10497	166
167530	145	188310	178	213240	114	D10498	166
167550	145	188610	178	213300	114	D10499	171
167600	142	188710	178	213380	114	D10500	161
167630	21	191170	79	213430	114	D10502	152
167640	21	193020	168	221000	219	D10503	177
168010	21, 144	193170	168	221100	219	D10504	264
168020	21, 144	193200	162	221200	219	D10505	264
168090	54, 141	193280	168	221300	219	D10508	264
168100	24, 54, 141	193290	168	221500	219	D10510	264
168140	72	193360	168	240346	184	D10513	265
168220	68, 72, 89	194010	167	240356	184	D10514	265
168260	68, 72, 89	194020	167	240366	184	D10515	265
168270	142	194030	167	241346	184	D10517	271
168340	142	194130	161	241356	184	D10518	271
168350	92	194150	161	241366	184	D10519	271
168360	92	194250	171	280009	152, 268	D10596	184
168390	24	195010	162	280019	268	D10597	257
168480	38, 143	195030	162	280029	268	D10642	177
168490	54	195060	172	280049	267	D10643	177

Index : Références - Part numbers - Artikelnummern

D10800	177	D13713	166	D14427	174	D14555	186
D10873	254	D13725	266	D14428	174	D14556	186
D10874	254	D13726	266	D14429	174	D14567	216
D11147	177, 270	D13807	241	D14430	174	D14568	216
D11268	270	D13808	241	D14431	174	D14569	216
D11399	161	D13810	241	D14432	174	D14574	255
D11400	171	D13816	124	D14434	262	D14575	255
D11479	42, 148	D13817	123	D14435	262	D14576	257
D11480	42, 148	D13874	151	D14436	262	D14577	256
D11481	42, 148	D13875	174	D14437	262	D14578	256
D11482	42, 148	D13876	261, 268	D14451	227	D14587	184
D11487	256	D13878	260	D14452	227	D14588	184
D11578	256	D13879	261	D14453	227	D14589	184
D11626	267	D13880	261, 269	D14467	229	D14590	83, 184
D11627	267	D13889	256	D14468	229	D14591	184
D11628	267	D14030	174	D14469	229	D14592	184
D11689	267	D14031	174	D14470	229	D14593	83, 184
D11809	260, 266	D14034	174	D14471	229	D14594	184
D11865	266	D14035	174	D14477	229	D14595	184
D11868	260, 266	D14037	134, 175	D14478	229	D14596	184
D11888	152	D14038	134, 175	D14479	229	D14598	216
D11889	265	D14039	134, 175	D14480	229	D14655	174
D11899	177	D14040	134, 175	D14482	225	D14685	250
D12334	41, 148	D14063	244	D14483	225	D14689	256
D12335	41, 148	D14116	151	D14484	225	D14706	182
D12336	41, 148	D14148	247	D14485	225	D14707	182
D12337	41, 148	D14165	212	D14486	225	D14708	182
D12338	42	D14166	213	D14487	223	D14709	182
D12339	42	D14170	160, 262	D14488	223	D14710	182
D12340	42	D14188	124	D14489	223	D14711	182
D12341	42	D14189	124	D14490	223	D14712	182
D12428	176	D14190	238	D14491	223	D14713	182
D12429	176	D14191	199	D14492	223	D14714	181
D12430	141, 176	D14195	244	D14493	223	D14715	181
D12449	267	D14208	261, 269	D14494	223	D14716	181
D12450	267	D14214	261	D14495	223	D14721	266
D12699	165	D14249	202	D14496	223	D14722	96, 165
D12711	134, 176	D14311	257	D14500	222	D14724	222
D12712	134, 176	D14312	255	D14501	222	D14725	222
D12713	180	D14313	255	D14502	222	D14726	222
D12714	180	D14314	255	D14503	222	D14732	225
D12715	180	D14315	256	D14507	224	D14733	225
D12867	166	D14316	255	D14508	224	D14734	225
D12953	135, 143, 242	D14320	110, 207	D14509	224	D14735	225
D13019	108	D14321	110, 207	D14510	224	D14736	225
D13034	134, 176	D14322	110, 207	D14511	230	D14737	226
D13035	134, 176	D14323	110, 207	D14512	230	D14738	226
D13205	180	D14324	206	D14513	230	D14739	226
D13206	180	D14325	206	D14514	230	D14740	226
D13207	180	D14326	244	D14515	230	D14741	226
D13254	264	D14327	247	D14517	152	D14742	226
D13255	264	D14331	261	D14529	184	D14743	198
D13256	264	D14345	124	D14530	184	D14744	198
D13257	264	D14348	124	D14531	184	D14745	198
D13260	264	D14352	262	D14535	182	D14746	227
D13262	265	D14353	238	D14536	182	D14747	222
D13263	264	D14354	238	D14537	252	D14752	223
D13277	177	D14357	202	D14538	251	D14753	223
D13288	137	D14358	202	D14539	251	D14754	223
D13609	151	D14362	261	D14540	196	D14755	223
D13610	151	D14421	174	D14542	196	D14756	222
D13620	247, 248, 250	D14422	174	D14544	196	D14757	222
D13621	247, 248, 250	D14423	174	D14547	197	D14758	222
D13622	247, 248, 250	D14424	174	D14549	197	D14760	234
D13624	176	D14425	113, 115, 174	D14552	197	D14762	234
D13710	161	D14426	113, 115, 174	D14553	197	D14779	223

Index : Références - Part numbers - Artikelnummern

D14780	264	D16025	147	D16130	249
D14781	113, 175	D16026	183	D16131	248
D14782	113, 175	D16027	183	D16132	248
D14802	256	D16028	228	D16133	250
D14811	60	D16029	125	D16134	250
D14824	256	D16030	217	D16135	250
D14846	115, 266	D16031	183	D16150	224
D14847	115, 266	D16032	183	D16151	224
D14850	188	D16033	246	D16152	224
D14851	188	D16034	236	D16153	224
D14852	189	D16035	232	D16155	187
D14855	189	D16036	252	D16156	187
D14856	189	D16038	239	D16157	187
D14857	186	D16039	239	D16160	203
D14879	165	D16040	211	D16161	224
D14880	186	D16041	211	D16162	252
D14885	266	D16042	200	D16163	251
D14922	235	D16043	247	D23301	232
D14925	234	D16044	244	D23354	232
D14926	234	D16045	244	D23363	232
D14928	235	D16046	244	D23401	232
D14929	235	D16047	210	D23501	232
D14930	235	D16048	210	D23513	232
D14931	235	D16049	210	R12486	262
D14932	235	D16050	210	R12499	265
D14933	235	D16051	211	R12575	267
D14934	235	D16052	211	R12576	267
D14935	235	D16053	211	R14173	269
D14963	205	D16055	244	R14338	97, 270
D14964	205	D16056	238	R14339	97, 270
D14965	192	D16058	232	R14364	151
D14966	192	D16067	213	R14407	265
D14967	193	D16068	213	R14412	113, 115, 270
D14968	190	D16069	172	R14413	113, 115, 262, 270
D14980	115, 266	D16070	172	R14416	270
D14983	115, 266	D16071	172	R14418	113, 115, 269
D14984	115, 260, 266	D16072	172	R14426	113, 115, 269
D14985	269	D16073	172	STA	242
D14989	235	D16074	241		
D14990	182	D16075	238		
D14991	182	D16076	238		
D14994	199	D16077	213		
D15048	199	D16086	180		
D15056	122	D16087	180		
D15077	190	D16088	180		
D15093	192	D16089	125		
D15094	193	D16093	217		
D15095	193	D16099	258		
D15100	194	D16100	258		
D15155	262	D16103	180		
D16001	236	D16104	180		
D16003	236	D16105	180		
D16004	238	D16108	147		
D16005	238	D16109	147		
D16006	123	D16110	189		
D16007	258	D16111	187		
D16008	183	D16114	191		
D16009	183	D16115	208		
D16010	217	D16118	202		
D16011	123	D16119	191		
D16012	228	D16120	191		
D16017	238	D16122	212		
D16018	238	D16123	212		
D16022	203	D16124	194		
D16023	203	D16126	244		
D16024	147	D16129	249		

N° d'homologation - Homologation number - Homologationsnummer

E2	781	FE80	164	E20	0021276	STOP	125
E2	1295	SMD00	167	E1	003244	R104	180
E2	2040	LC8	128	E2	0050	C199	154
E13	2060	725	148	E11	010002	R70	182
E2	2065	SMD98	171	E24	020078	FE12	177
E3	2617	2751	152	E20	020889	DX	176
E1	3110	F930	123	E2	04010	SMD98	161
E4	4052	FRR	124	E2	04075	LC9	135
E2	4054	FPL93	168	E2	05010	FE04	160
E2	4089	FE94	161	E2	05011	FE04	170
E2	4091	FE94	171	E2	05021	SMD04	165
E2	4093	FE94	167	E2	05022	SMD04	160
E2	4701	FE87	169	E2	05023	SMD04	170
E2	4703	FE87	158	E2	06018	C105	154
E2	5047	ICDL94	157	E2	06024	LC5T	140
E2	5052	FE95	162	E2	07092	DXLC8	176
E2	5126	FE95	172	E2	08028	SRD07	155
E9	6653	FRR	124	E2	09025	ICDL07	156
E2	7001	EPP96	152	E20	1390	W97	172
E2	7001	EPP98	152	E20	1397	W97	172
E2	7102	FE02	162	E20	1398	W97	172
E2	7139	ICDL94	157	E2	21003	LC15	136
E11	7573	2963	186				
E2	8005	LC5	137				
E2	8040	SMD98	166				
E13	8434	725	148				
E2	9056	LC7T	145				
E2	10035	DX	177				
E2	10073	SRD08	155				
E2	10113	LC9 LED	118				
E13	10989	BX868	151				
E2	11017	EPP96 LED	151				
E2	11128	ICDL10	156				
E9	11734	SLIM	148				
E2	12007	LC8	126				
E2	12056	C105	154				
E2	12164	LC10 LED	119				
E4	13992	FRR	124				
E2	14010	FA3 LED	174				
E2	14085	LC11	116				
E2	14086	LC11	116				
E9	14260	SESA AIRGLOW	123				
E9	14261	SESA SOLAR	122				
E2	16005	CTL15	120				
E2	16007	BL15	120				
E2	16027	LC12 LED	112				
E2	16059	ICDL15	156				
E2	16111	CTL14	148				
E2	18042	LC12 G LED	112				
E2	19014	LPL18	150				
E2	19106	LCR19	114				
E2	19140	SL1000	186				
E4	23271	FRR	124				
E2	86710	FE87	163				
E2	86711	FE87	172				
E2	88017	LC7	142				
E2	88033	LC6	145				
E2	88034	LC6	145				
E2	88035	LC7	142				
E2	88714	FE88	179				
E2	90711	FE81	158				
E2	91098	LC4	146				
E2	91099	LC4	146				
E2	91715	FE80	164				
E13	0001	R104	180				
E13	0002	R104	180				



Feux arrière - Rear lamps - Heckleuchten



p. 112



p. 113

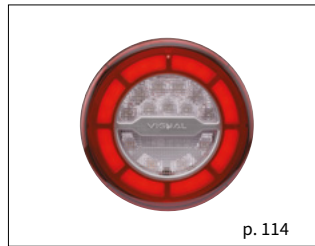

p. 114



p. 114



p. 116-117

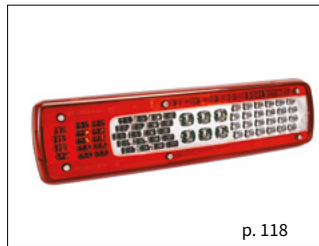

p. 118



p. 119



p. 120

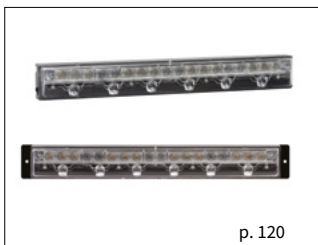

p. 120



p. 122



p. 122



p. 123



p. 123



p. 123



p. 124



p. 124

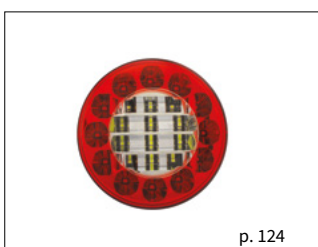

p. 124

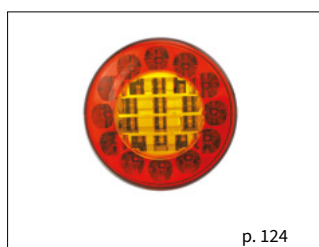

p. 124



p. 125



p. 125

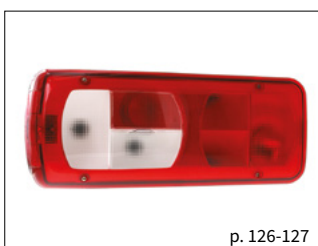

p. 126-127



p. 128



p. 129-130



p. 131-132



p. 133



p. 134



p. 135



p. 136

Index images - pictures - Abbildung

Feux arrière - Rear lamps - Heckleuchten

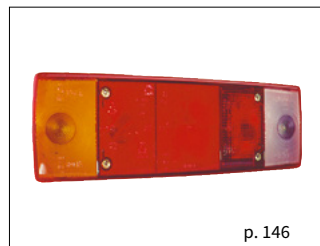
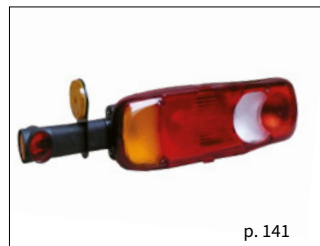
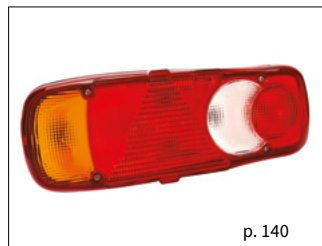

Eclaireurs de plaque - Number plate lamps - Kennzeichenleuchten



Feux clignotants - Flasher lamps - Fahrtrichtungsanzeiger

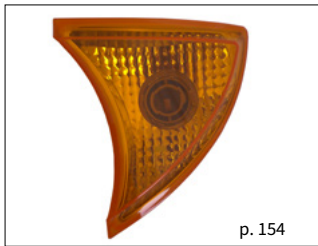

p. 154



p. 154

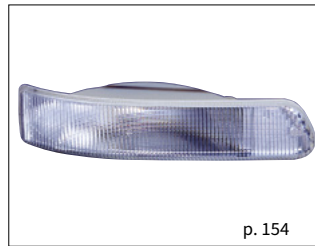

p. 154



p. 154



p. 155



p. 155



p. 155



p. 156

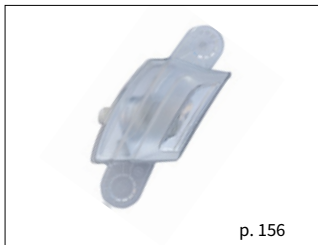

p. 156

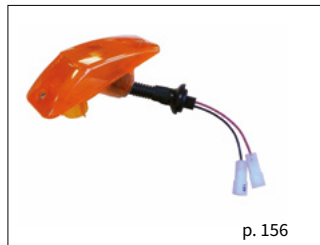

p. 156



p. 157



p. 157



p. 158

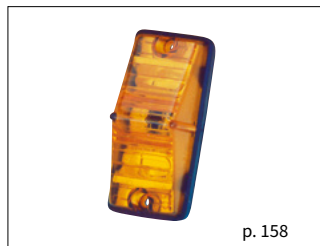

p. 158

Feux de position - Position lamps - Positionsleuchten

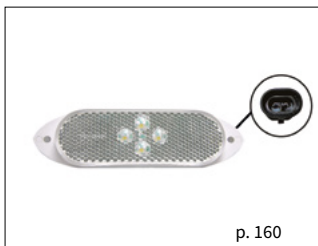

p. 160

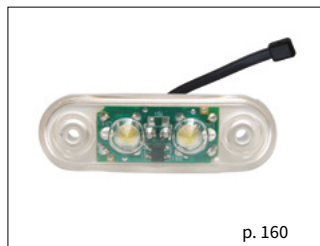

p. 160



p. 161



p. 161



p. 162

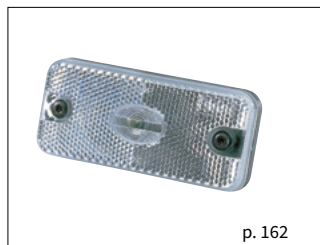

p. 162



p. 162



p. 163

Index images - pictures - Abbildung

Feux de position - Position lamps - Positionsleuchten

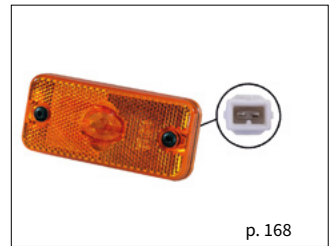
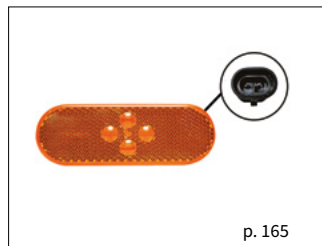

Feux de gabarits - End outline marker lamps - Begrenzungsleuchten



Feux de gabarits - End outline marker lamps - Begrenzungsleuchten



Signalisation passive - Warning products - Warnmarkierungen

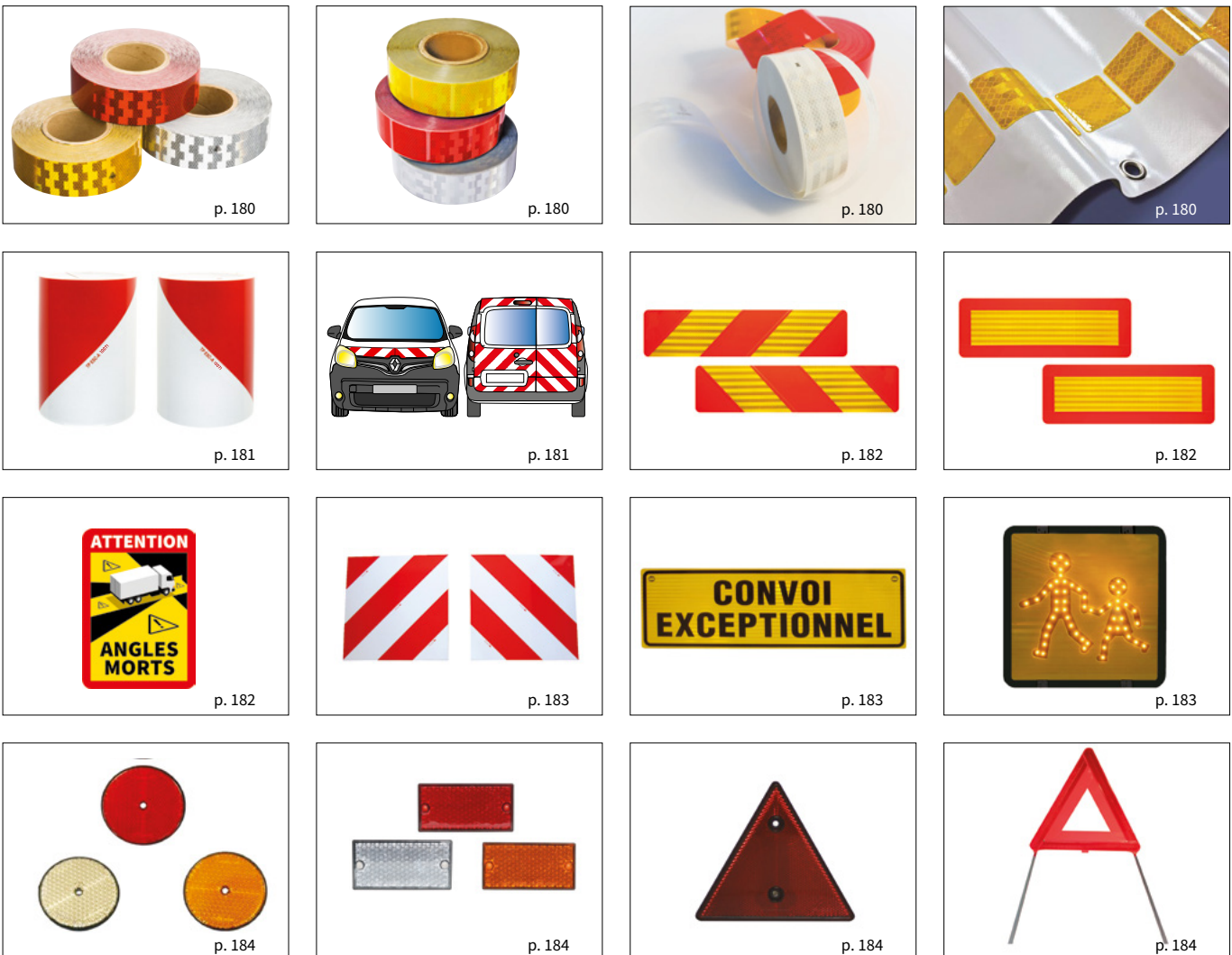

Index images - pictures - Abbildung

Phares de travail - Work lights - Arbeitsscheinwerfer



Éclairage de sécurité - Warning lights - Sicherheitsbeleuchtungen



Phares de conduite - Headlights - Fahrlichter

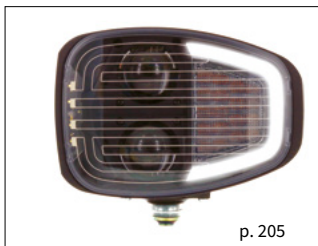

Feux auxiliaires - Auxiliary lights - Zusatzscheinwerfer

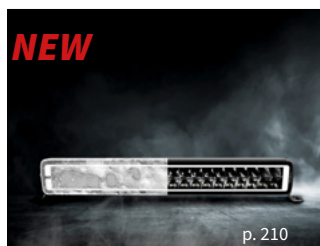

Index images - pictures - Abbildung

Feux auxiliaires - Auxiliary lights - Zusatzsscheinwerfer



Éclairage intérieur - Interior lights - Innenraum-Beleuchtungen

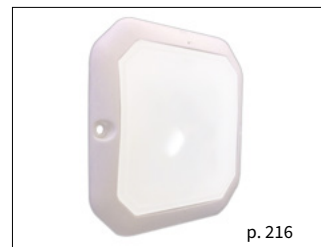
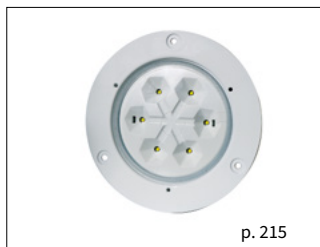

Gyrophares - Beacons - Rundumkennleuchten



Gyrophares - Beacons - Rundumkennleuchten



Index images - pictures - Abbildung

Gyrophares - Beacons - Rundumkennleuchten

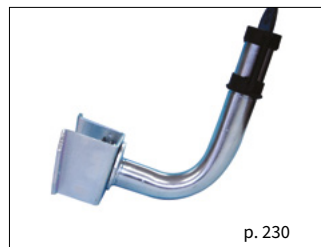
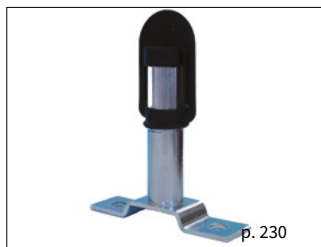

Rampes lumineuses - Lightbars - Warnbalken

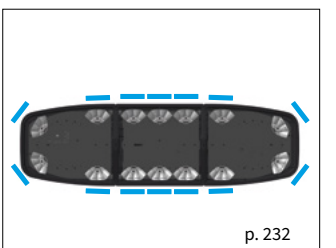
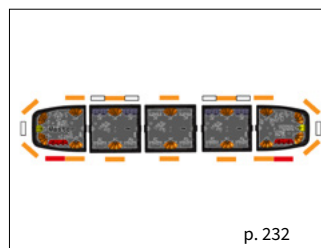
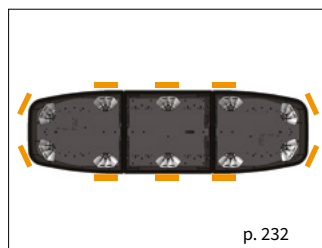

Triflash



Triflash

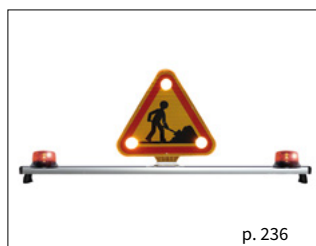

Feux de pénétration - Directional lights - Warnleuchten

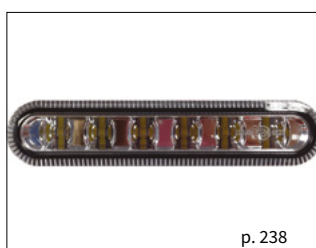

Alarmes sonores de recul - Back-up alarms - Rückfahrwarner



Index images - pictures - Abbildung

Systemes caméras - Camera systems - Kamera-Systeme



Coffres porte extincteur - Extinguisher boxes - Feuerlöscherbehälter



Prises et câbles spiralés - Plugs and coils - Stecker und Spiralkabel



Prises et câbles spiralés - Plugs and coils - Stecker und Spiralkabel

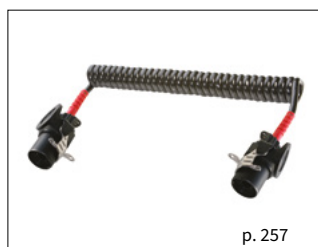
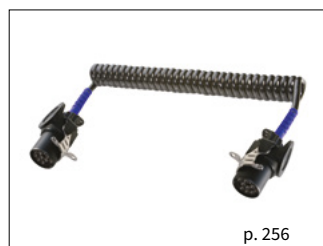

Prises USB - USB ports - USB-Buchse



Connecteurs - Connectors - Anschlussstecker

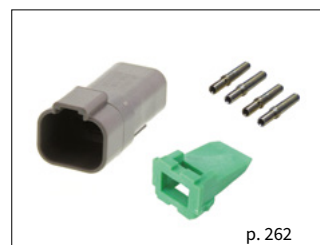
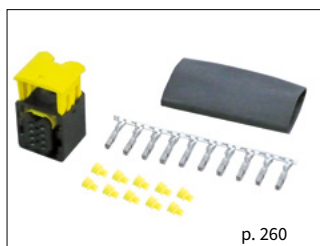
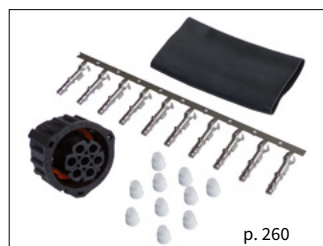

Index images - pictures - Abbildung

Faisceaux - Harnesses - Kabelsatz

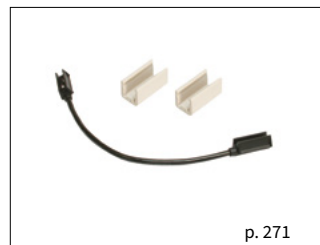
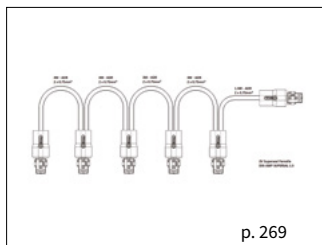
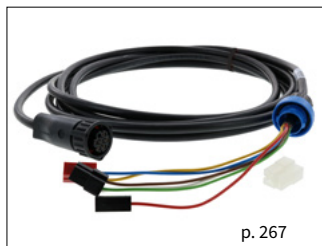
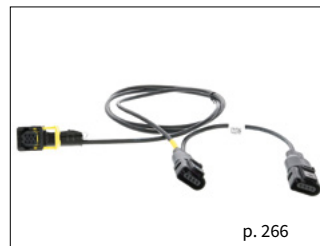
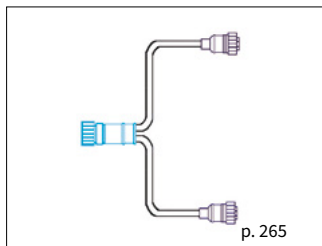
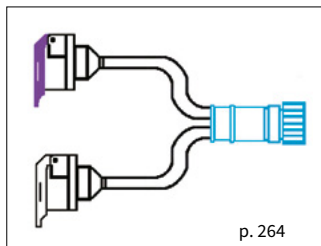

Systèmes câblage et feux - Wiring and lamps systems - Verkabelung und leuchten systeme

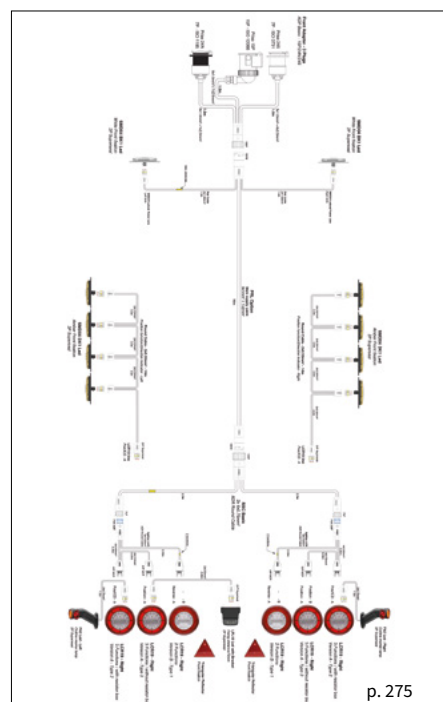
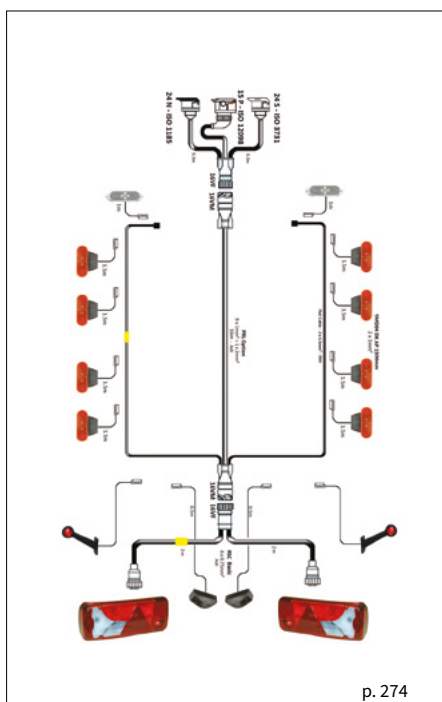
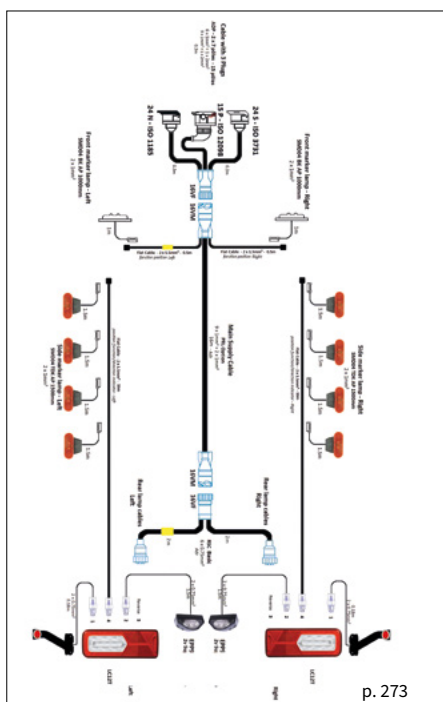

MISE EN GARDE SUR LES RISQUES JURIDIQUES DE LA CONTREFAÇON
WARNING ON LEGAL RISKS OF ORIGINAL PARTS COPIES / FORGERY
HINWEIS AUF DIE RECHTLICHEN RISIKEN BEI FER VERWENDUNG

MISE EN GARDE SUR LES RISQUES JURIDIQUES DE LA CONTREFAÇON DES PIÈCES D'ORIGINE

Les **remplacements** ou **modifications** de composants autres que ceux montés et recommandés par le constructeur peuvent remettre en cause la sécurité des usagers de la route (diminution des performances photométriques).

Ex : **Le montage d'un cabochon adaptable sur un feu d'origine Vignal est interdit.**

Toute opération de ce type sur le matériel sera **à la charge entière de celui qui sera intervenu** et pourra **remettre en cause** l'homologation du véhicule délivrée par les autorités compétentes.

Le fabricant dégage sa responsabilité réglementaire.

La contrefaçon et la concurrence déloyale de pièces sont condamnées par la loi civile et pénale :

- La contrefaçon engage la responsabilité civile et pénale du fabricant, du revendeur, voire dans certains cas de l'utilisateur des pièces de contrefaçon.

- La concurrence déloyale engage la responsabilité civile du fabricant et du revendeur de copies serviles; en tirant de cette opération un avantage injustifié, **il fausse les règles normales de la concurrence** et réalise de ce fait **un acte de parasitisme** en détournant le travail de recherche et de conception, ainsi que le savoir-faire des constructeurs.

WARNING ON LEGAL RISKS OF ORIGINAL PARTS COPIES / FORGERY

The **remplacements** or **modifications** of components other than those assembled and recommended by the manufacturer can reduce the safety of the road users (reduction in the photometric performances).

Ex : **The assembly of an adaptable lens on an original lamp Vignal is prohibited.**

Any operation of this type on the material **will be judged as responsibility of who intervened** and will **compromise the homologation of the vehicle** delivered by the authorities.

The manufacturer declines all responsibilities.

The forgery and the unfair competition of original parts are condemned by the civil and penal law :

- The forgery engages the civil and penal liability of the manufacturer and the retailer, even in certain cases of the user of the forgery parts.

- The unfair competition engages the civil liability of the manufacturer and the retailer of forged parts; by taking an unjustified advantage from this operation, the forgery **distorts the normal rules** of competition and carries out an **act of parasitism** by diverting the design and R&D task, as well as know-how of the manufacturers.

HINWEIS AUF DIE RECHTLICHEN RISIKEN BEI FER VERWENDUNG VON NACHBAUTEILEN ANSTELLE VON ORIGINALERSATZTEILEN

Der **Austausch** oder die **Modifikation** von Teilen, die nicht in der Erstausrüstung montiert und vom Hersteller empfohlen wurden, können die Sicherheit der Verkehrsteilnehmer beeinträchtigen (Verringerung der lichttechnischen Leistung).

Beispiel: **Die Verwendung einer nachgebauten Lichtscheibe auf einer VIGNAL-Heckleuchte ist nicht zulässig.**

Jede Verwendung dieses Materials wird **zu Lasten des Verwenders** ausgelegt und kann die **Zulassung des Fahrzeugs durch die Zulassungsstellen in Frage stellen.**

Der Fahrzeughersteller entzieht die gesetzliche Gewährleistungspflicht.

Die Fälschung (Nachbau) von Originalteilen und der unlautere Wettbewerb werden durch das Zivil- und Strafrecht verurteilt:

- Die Fälschung (Nachbau) von Originalteilen zieht die zivil- und strafrechtliche Haftung des Herstellers, des Wiederverkäufers und in bestimmten Fällen auch des Benutzers nach sich.

- Der unlautere Wettbewerb zieht **die zivilrechtliche Haftung des Herstellers und des Wiederverkäufers von Nachbauteilen nach sich**; sie ziehen aus dieser Operation einen ungerechtfertigten Nutzen, und verfälschen die normalen Regeln des Wettbewerbs, indem sie die Forschungs- und Konzeptionsarbeit sowie das Know-How der Konstrukteure nutzen.

NORMES ET RÈGLEMENTATION

STANDARDS AND REGULATIONS

NORM UND REGLEMENTIERUNG

Les extraits de réglementation sont disponibles sur notre site web.

Les éléments sont extraits du règlement ECE R48 concernant la majorité des véhicules.
Se référer au règlement pour des configurations particulières.

Les produits doivent être homologués selon le dernier amendement en vigueur
L'utilisateur est responsable de la conformité de l'équipement de son véhicule.

VIGNAL s'engage sur la conformité de ses produits.



Le sigle ADR signifie que le produit est homologué pour le montage sur des véhicules qui satisfont aux dispositions ADR (accord européen relatif au transport international des marchandises dangereuses par route).

Les produits ADR ont un indice de protection d'au moins IP54.

L'indice de protection IP détermine le degré de protection du matériel contre la pénétration des corps solides (1er chiffre) et des liquides (2ème chiffre).



Exemple : IP54

1er chiffre : 5 => Protégé contre les infiltrations de poussière

2ème chiffre : 4 => Protégé contre les projections d'eau (haute pression) de toutes les directions

The regulation extracts are available on our website.

The elements are extracts from the ECE R48 regulation which concern most of the vehicles.
Please refer to the regulation for any special configuration.

The products must be homologated according to the last amendments in force.
The user is responsible for the conformity of its vehicle's equipment.

VIGNAL is committed to the conformity of its products



The ADR sign means the product is homologated on vehicles which are under ADR regulations (European Agreement concerning the International Carriage of Dangerous Goods by Road).

The ADR products have an ingress protection rating of at least IP54.

IP Code classifies and rates the degrees of protection provided against the intrusion of solid objects (1st number) and water (2d number)



Example : IP54

1st number : 5 => Protected against dust

2d number : 4 => Protected against splashing water from all directions

Auszüge aus der Reglementierung sind auf unserer Webseite ersichtlich.

Es handelt sich um die für die meisten Fahrzeuge zutreffenden Auszüge der Reglementierung ECE R48.
Für Sonderfälle sehen Sie bitte die komplette Reglementierung ein.

Die Produkte sind nach dem aktuellstem Änderungsstand zu homologieren.
Der Fahrzeugführer ist für die zulässige Ausrüstung seines Fahrzeuges verantwortlich.

VIGNAL garantiert die Konformität der Produkte.



Das ADR Zeichen bedeutet, dass das Produkt für den Einbau in Fahrzeuge mit ADR Zulassung (Europäisches Übereinkommen über die internationale Beförderung gefährlicher Güter auf der Straße) geeignet ist. ADR-Produkte haben einen Schutzfaktor von mindestens IP54.

Der IP Schutzfaktor bestimmt den Schutzgrad eines Bauteils gegenüber das Eindringen von festen Körpern (erste Ziffer) und von Flüssigkeiten (zweite Ziffer).



Beispiel : IP 54

Erste Ziffer : 5 => Schutz gegen das Eindringen von Staub

Zweite Ziffer : 4 => Schutz gegen Spritzwasser aus allen Richtungen

NORMES ET RÈGLEMENTATION
STANDARDS AND REGULATIONS
NORM UND REGLEMENTIERUNG

Indice de protection

Indice	1 ^{er} chiffre (dizaine) = Protection contre la poussière	2 ^{ème} chiffre (unité) = Protection contre l'eau
0	Aucune protection.	Aucune protection.
1	Protégé contre les corps solides supérieurs à 50 mm.	Protégé contre les chutes verticales de gouttes d'eau.
2	Protégé contre les corps solides supérieurs à 12,5 mm.	Protégé contre les chutes de gouttes d'eau jusqu'à 15° de la verticale.
3	Protégé contre les corps solides supérieurs à 2,5 mm.	Protégé contre l'eau en pluie jusqu'à 60° de la verticale.
4	Protégé contre les corps solides supérieurs à 1 mm.	Protégé contre les projections d'eau de toutes directions.
5	Protégé contre les poussières.	Protégé contre les jets d'eau de toutes directions à la lance.
6	Totalement protégé contre les poussières.	Protégé contre les forts jets d'eau de toutes directions à la lance.
7	-	Protégé contre les effets de l'immersion (jusqu'à 1m).
8	-	Matériel submersible dans des conditions spécifiées (immersion prolongée) au delà de 1 m et pendant 30 minutes.
9K	-	Protection contre le nettoyage à haute pression.

International Protection

Level	1 st digit = Solid particles protection	2 nd digit = Liquid ingress protection
0	Not protected.	Not protected.
1	Protected against solid objects superior to 50 mm.	Protected against vertical dripping.
2	Protected against solid objects superior to 12,5 mm.	Protected against dripping (inclined 15°).
3	Protected against solid objects superior to 2,5 mm.	Protected against spraying water.
4	Protected against solid objects superior to 1 mm.	Protected against splashing of water from any direction.
5	Dust protected.	Protected against water jets by a nozzle.
6	Dust tight.	Protected against powerful water jets by a nozzle.
7	-	Protected against immersion up to 1 m.
8	-	Submersible equipment under specified conditions beyond 1 m for 30 minutes.
9K	-	Protected against close-range high pressure.

Schutzart

Kennziffer	Erste Kennziffer = Schutz gegen Fremdkörper	Zweite Kennziffer = Bedeutung: Schutz gegen Wasser
0	kein Schutz.	kein Schutz.
1	Geschützt gegen feste Fremdkörper mit Durchmesser ab 50 mm.	Schutz gegen Tropfwasser.
2	Geschützt gegen feste Fremdkörper mit Durchmesser ab 12,5 mm.	Schutz gegen fallendes Tropfwasser, wenn das Gehäuse bis zu 15° geneigt ist.
3	Geschützt gegen feste Fremdkörper mit Durchmesser ab 2,5 mm.	Schutz gegen fallendes Sprühwasser bis 60° gegen die Senkrechte.
4	Geschützt gegen feste Fremdkörper mit Durchmesser ab 1,0 mm.	Schutz gegen allseitiges Spritzwasser.
5	Geschützt gegen Staub in schädigender Menge.	Schutz gegen Strahlwasser (Düse) aus beliebigem Winkel.
6	Staubdicht.	Schutz gegen starkes Strahlwasser.
7	-	Schutz gegen zeitweiliges Untertauchen.
8	-	Schutz gegen dauerndes Untertauchen.
9K	-	Schutz gegen Wasser bei Hochdruck-/Dampfstrahlreinigung, spezifisch für Straßenfahrzeuge.



2024



DRL

Transport Vehicle Parts & Services

DRL

103 Ashbourne Ind Est,
Ashbourne,
Co Meath, A84 WK37, Ireland
01-8351944
sales@drl-irl.com
www.drl-irl.com



Ref: 99999CAD

Imprimé en France - Novembre 2023

www.vignal-group.com